

See more
on the web

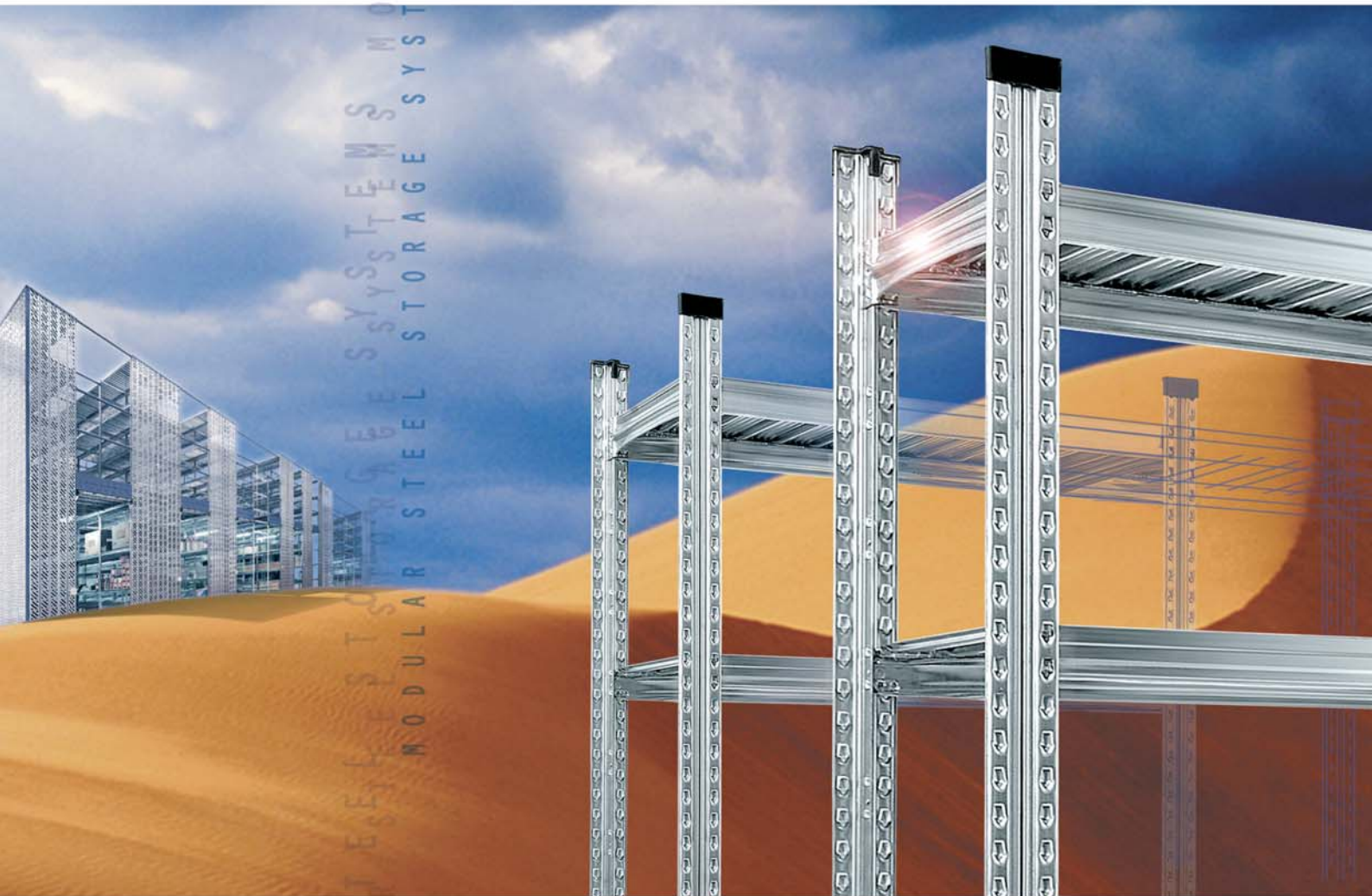

SUPER 1/2/3

PATENTED BOLTLESS SHELVING



TEMPORARY MODULAR



METALSISTEM[®]
STRUTTURE ED AUTOMAZIONE
MADE IN ITALY 

See more
on the web



THE GROUP



Founded in 1968, METALSISTEM commenced its activities specialising in the design and production of machinery for the cold profiling of metals. The experience gathered, numerous highly innovative patents resulting from intense research and development and the considerable market success of the first range of cold form zinc coated profiles quickly channelled METALSISTEM into the production of the latter of its activities.

Today the METALSISTEM Group is an articulated network of companies with its head office and main production facility in Rovereto, Italy. The Group has consolidated its position as one of the major industries within the Material Handling Sector.

Through products and services aimed at providing complete assistance for all warehousing, product showcasing and sales outlet requirements, the companies of the METALSISTEM Group are able to offer their customers a wide range of products of the highest quality, highly competitively priced, with very rapid delivery times and a first class back up service, as well as tailor made solutions providing efficient and rational use of internal storage areas and material handling environments.

Lightness, strength and modular form, coupled with the ease of integrating and expanding already existing structures are but a few of the successful features of the METALSISTEM storage and shelving systems.

The success of the METALSISTEM Group is the result of a precise managerial choice based on research of new production technologies and continuous development and innovation of its product range.

A direction which has produced numerous international patents (testament to the uniqueness of the METALSISTEM product), continuing improvements in safety, quality and versatility. METALSISTEM's company strategy is to offer

products of the highest quality, very competitively priced, with rapid delivery times backed up by a first class service.

The numerous product lines are conceived and designed by METALSISTEM's internal Research and Development Centre, as are the profiling lines and equipment required for their manufacture.

The automated production facilities for the cold profiling of metals have enabled METALSISTEM to achieve one of the highest levels of productivity in the world, today.

Rigorous laboratory tests are conducted on the raw material entering production, and on the final product, thus ensuring the continuing evolution of efficiency and quality standards.

All products have elevated structural characteristics and ensure high quality standards recognised by the most important European certification bodies, such as Germany's TÜV Product Service GmbH, Austria's Ö-NORM, Rome's I.S.P.E.S.L., UNICMI - ACAI/CISI (Associazione Costruttori Acciaio Italiani - Sezione Costruttori Italiani di Scaffalatura Industriale), the latter of which METALSISTEM has membership, and others.

The company's ISO 9001 quality assurance system as well as its environmental management system ISO14001 and the health and safety BS OHSAS 18001, are certified by RINA.

With an annual turnover of exceeding 260 Million Euro, the METALSISTEM Group premises occupy a total area of 230.000 m², 125.000 of which are dedicated to production.

The METALSISTEM Group affiliated companies and distributors provide a world wide commercial network, able to satisfy the most demanding needs.

We value greatly the high level of trust that is placed in us by our customers and feel that it is proof of the quality and reliability of our products.



STANDARD SPECIFICATIONS CALCULATION AND SAFETY STANDARDS

The correct use of a product, distinguishes both the Customer and the Manufacturer. METALSISTEM recommends that Customers make use of their product in strict conformity with the design characteristics given and standards of best practice. The design and assembly of the racking systems must be carried out by qualified personnel.

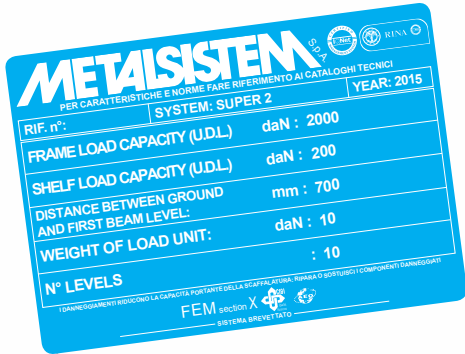

METALSISTEM declines all responsibility for improper or non authorized use of the racking and its accessories.

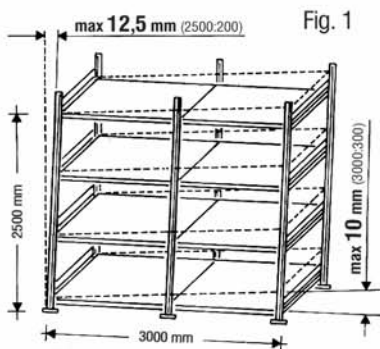

a) Floor slab loading

Loading capability should be checked before installation.

b) Site installation

It is of utmost importance that installations are assembled by skilled labour only. Frames should be built in strict accordance with the assembly diagram shown at right. Particular attention should be paid to a proper assembly and location of security pins.

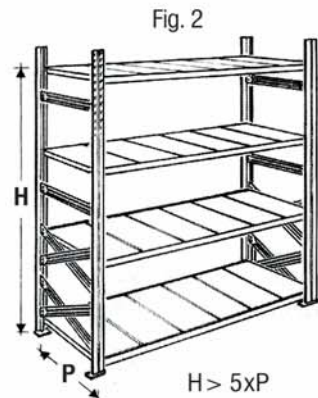

c) Rack alignment

Once the shelving is assembled, it is necessary to align it vertically and horizontally. The perpendicular deviation should not exceed 1/200 of the height (with a maximum of 15 mm) and correspondingly the horizontal deviation 1/300 of the bay length (see Fig. 1).

d) Load bearing capacity plate

Load capacity plates should be fixed in a prominent position and show the product series, the year of construction, the maximum load per bay, per shelf and per m² (in the case of platforms and/or two-tier-structures), as well as the weight of the load units and the distance from the ground to the first load level.

e) Rack safety standard

In the case of hand loaded static shelving, if the height of the frame is over 3 metres or exceeds over 5 times its depth, the frames must be securely bolted to the floor slab (using the heavy duty base plate art. 67006.95) and fitted with wall ties or overhead ties (see fig. 2). It is not allowed to use single sided shelving that exceeds over 8 times its depth, unless the frames are connected through walkways or fitted with wall ties or equivalent. The use of cross bracing (vertical and horizontal cross bracing) is necessary in the case of rack runs with frame heights over 3 metres, with less than 4 bays or with distances of more than 700mm in height between the load levels. In such cases it is necessary to provide vertical and horizontal cross bracing in intervals of at least one bay each 8 bays in a row. The frames must be securely bolted to the floor slab using the heavy duty base plates (art. 67006.95) and the locking frame spacer bars. As an alternative solution to the use of cross bracing customers may fit the shelving with wall ties or similar. This is valid only in case that the wall or the structure is adequate for that scope and provide an equal or better grade of constraint compared to cross bracing. Within seismic regions it is not allowed at all to use any type of wall ties or similar. For specific calculations and design customers should contact the METALSISTEM Technical Department.

f) Installation design

Super 1-2-3 structures are to be used as hand loaded shelving only and not as pallet racking, with forklifts, or with wheeled equipment on two-tier-structures. METALSISTEM declines all responsibility for improper or non authorized use of the shelving and its accessories.

g) Two tier structures/platforms

Two tier structures with suspended walkways are to be designed exclusively with the Super 3 system and must comply with all safety recommendations. In case of platforms with continuous floor/decking (see page 5 - case "B"), the frames are to be assembled as shown in the assembly diagram, i.e. using exclusively diagonal spacer bars, at centre distances of 264 mm, up to the level of the platform. Uprights must be assembled with locking frame spacer bars and heavy duty base plates (art. n° 67006.95), securely bolted to the floor slab. Staircases must be adequately reinforced and built with the reinforced Super 3 uprights only (art. 99230--95), either side of the staircase. The correct use of all safety components mentioned in this brochure is mandatory. The maximum load bearing capacity of walkways/decking within two-tier-structures and platforms is 300 daN/m², the maximum width of walkways is 1200 mm, and the maximum shelf bay length is 1500 mm. Two tier-structures and platforms have to be equipped with appropriate vertical and horizontal cross bracing. The frames must be fitted with overhead ties (art. n° 67400.95).

h) Software reference

The structural calculation reference standards are:

- UNI EN 15512:2009; UNI EN 15620:2009; UNI EN 1993-1-3:2007 Eurocode 3.

Material reference standards are:

- UNI EN 10346:2009; UNI EN 10149-1:1997; UNI EN 10149-2:1997; UNI EN 10204:2005.

Other reference standards:

- UNI EN 15635:2009; ACAI-CISI - Testo Unico - dated 11.05.2004 and 26.02.2004.

i) Calculation

The calculation is executed with the ANSYS software and based on finite elements.

l) Frame load capacity

The frame load bearing capacities stated in this brochure are calculated in compliance with the following criteria: the first shelf level must be fitted at no more than 700 mm from the ground and the following levels at intervals not exceeding 500 mm, with a minimum of 4 interconnecting bays. Frames are to be bolted to the floor slab. Super 1-2-3 shelving series has been designed for hand loaded use only, and calculated without considering any significant horizontal loads.



m) Shelf load bearing capacity

Data for shelf load bearing capacities shown in the brochure are to be understood as referring to uniformly distributed loads with a deflection equal to 1/200 of the shelf length.

The beam locking pins must always be fitted.

n) Custom-built applications



The METALSISTEM Technical Department is at its customers' disposal for any specific calculation or custom-built application.

METALSISTEM reserves the right to apply technical changes to the product. Data, characteristics and dimensions given in this document are merely indicative.

FRAME BRACING ASSEMBLY DIAGRAM

In depth 320 - 400 - 500 - 600 - 700 - 800

LEGEND

-  Diagonal / Horizontal Spacer Bars
-  Locking Frame Spacer Bars



See more



on the web

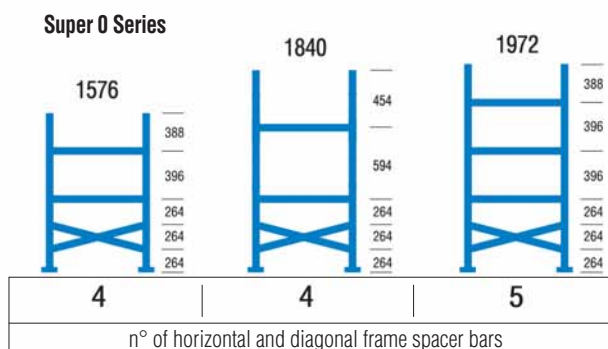
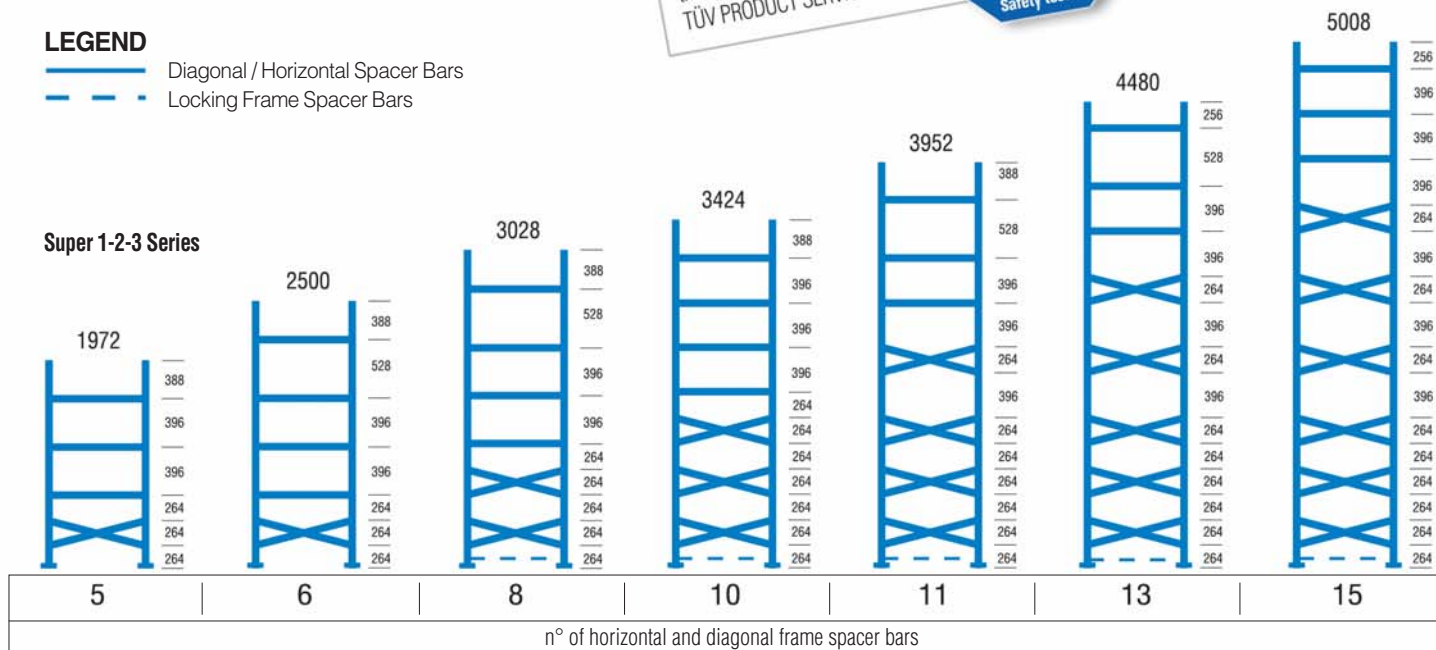

Super 0 uprights and frames are allowed with the use of Super-ZERO beams and shelves, only. Bay lengths 900/1050/1200 mm only, with a max. load capacity of 200 daN per shelf, for uniformly distributed loads.

TWO TIER STRUCTURES PLATFORMS

In case of two tier structures with suspended walkways the frames are to be assembled as shown in case "A" at left (i.e. the standard frame assembly diagram). In case of platforms with continuous floor decking, the frames have to be assembled with pairs of diagonal spacer bars only, at centre distances of 264 mm, up to the level of the platform (see case "B" at left).

In both cases the frames must be securely bolted to the floor slab using the heavy duty base plates (art. n° 67006.95) and the locking frame spacer bars.

Staircases made from standard components and integrated into the two-tier-structure have to be reinforced in an appropriate way, using the reinforced Super 3 upright (art. n° 99230--95) either side of the staircase. METALSISTEM strongly recommends to comply with all safety standards mentioned in this brochure.

The maximum load bearing capacity of walkways/decking within two-tier structures or platforms is 300 kg/m² and the maximum width of the walkways is 1200 mm. The maximum shelf bay length is 1500 mm.

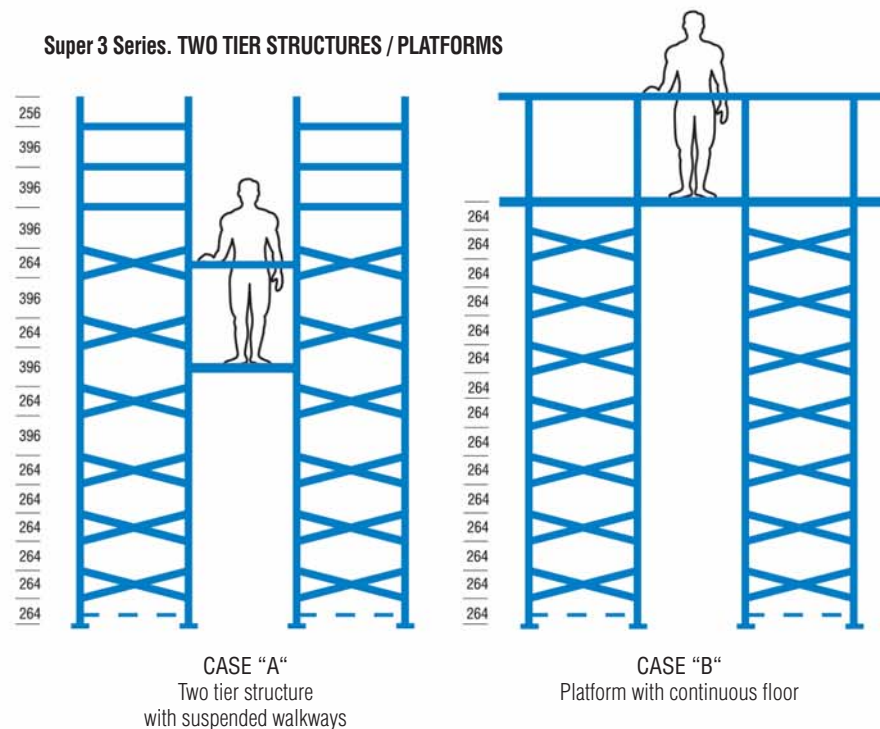





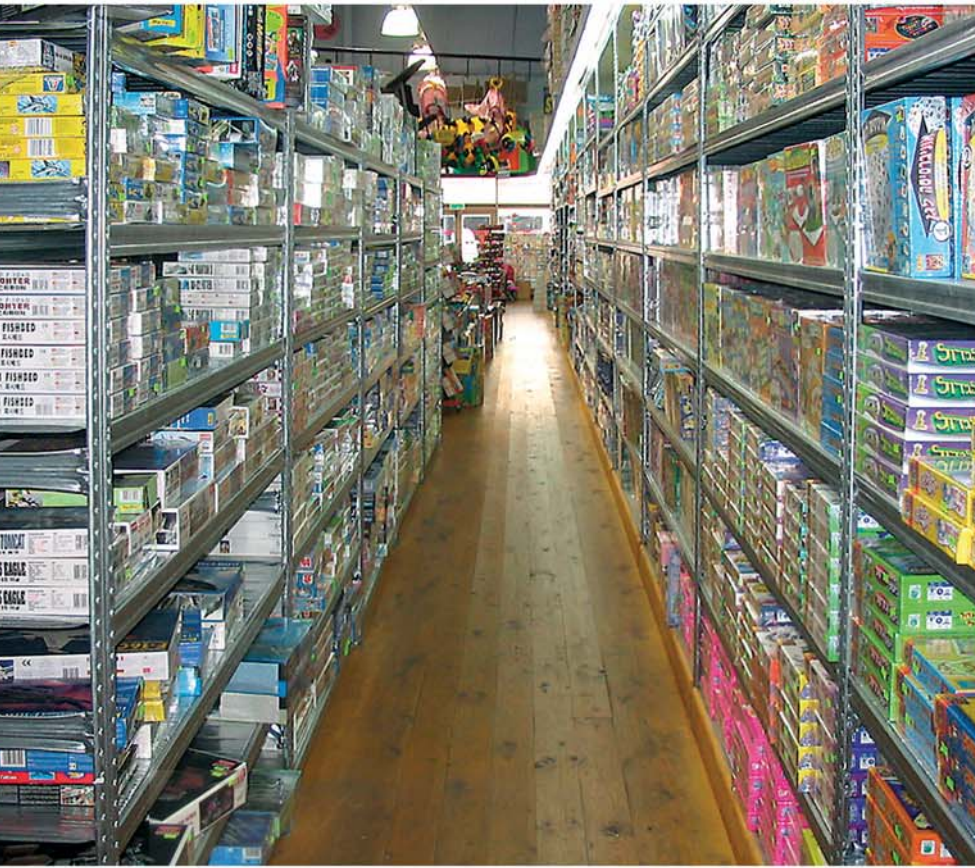

THE COMPANY TODAY

METALSISTEM products are now in use in a great many installations throughout the world, and after more than 45 years production, we value greatly the high level of trust that is placed in us by our customers and feel that it is proof of the quality of our products.

The shelving components are produced on fully automated production lines. The folding and cold processing techniques developed by METALSISTEM are designed to obtain light and extremely strong components.

Lightness, strength and modular form coupled with the ease of integrating and expanding already existing structures are but a few of the successful features of the METALSISTEM Industrial Storage Systems. Ideal storage solutions for a whole host of products supplied worldwide are created here thanks to a total commitment to research and development.

All METALSISTEM components are subjected to regular and rigorous technical tests. These cover both uniformly distributed and concentrated loadings.





THE PRODUCT

The fully adjustable Super 1-2-3 systems have been designed to meet the needs of light to medium duty storage. They are also highly suitable for the construction of two tier structures (with the Super 3 system).

The design of the various components is the result of rigorous technical testing and the highly specialised knowledge developed over years of experience in the field of metal processing.

This experience has enabled METALSISTEM to offer innovative products of the highest quality, highly competitively priced, and to produce a highly technical solution to the most important shelving problems, such as rapid as-



sembly, stability, low cost and load bearing capacity.

The design allows for high load bearing from light gauge materials. The use of high quality zinc coated steel ensures a high level of durability.

The structural components of the Super 1-2-3 systems are made from high tensile steel, certified according to EN 10204 3.1.



See more



on the web



The safety and the quality of the product has always been a primary aim of METALSISTEM and is recognised by TÜV PRODUCT SERVICE in Munich, one of the most rigorous EU commissions in the field of quality and safety certification. The product meets the requirements of the Equipment Safety Law.

Thanks to its attractive high-tech design, Super 1-2-3 shelving is trendy and pleasing to the eye. It can provide unique and cost effective solutions for shopfitting and applications in domestic environments as well.

See examples at left as well as on page 34, 35 and overleaf.

ASSEMBLY INSTRUCTIONS

Base plates

Fit the steel base plate onto the upright, using pliers to guide the two tongues on the plate into the nibs on the upright. Then tap the base plate into the nibs with a hammer (see sketch below).

Plastic base plates (Ref. 1) should be used for the Super 0 and Super 1 series only. They may be used as well for applications in domestic environments, with modest load bearing capacities. Double plastic base plates are available for back-to-back bays. Both items (single and double base plates) are also used as top caps for uprights (Ref. 20/29).

Heavy duty base plates (Ref. 1b) must be used in the following cases:

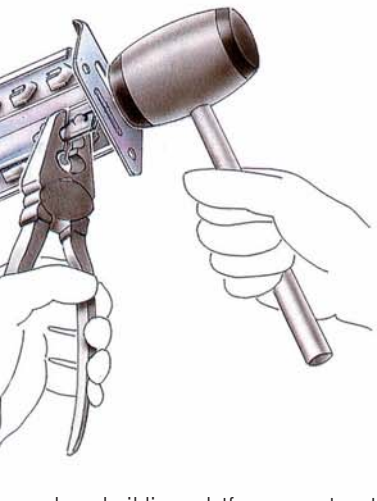

- when building platforms or two-tier structures with suspended walkways;
- when building staircases, under the uprights of the staircase;
- if the height of the shelving is over 3 metres or exceeds over 5 times the depth of the shelving.

Heavy duty base plates are always to be assembled in conjunction with locking frame spacer bars.

In all other cases customers may use the standard steel base plate (Ref. 1). Shims in 1 and 2 mm gauge are available for steel base plates.

Spacer bars

To fit spacer bars, refer to the diagram on pages 4 and 5 to determine the exact position and quantity.

Insert the horizontal and diagonal spacer bars into the grooves in the corner of the upright, locating the wide part of the slot over the nibs on the upright and keeping the spacer bars tight to the upright, in order to keep it square; then tap down into the narrow part of the slot alternating from side to side.

To achieve correct assembly, the spacer bar anti-release tongues should be closed (Ref. 2).

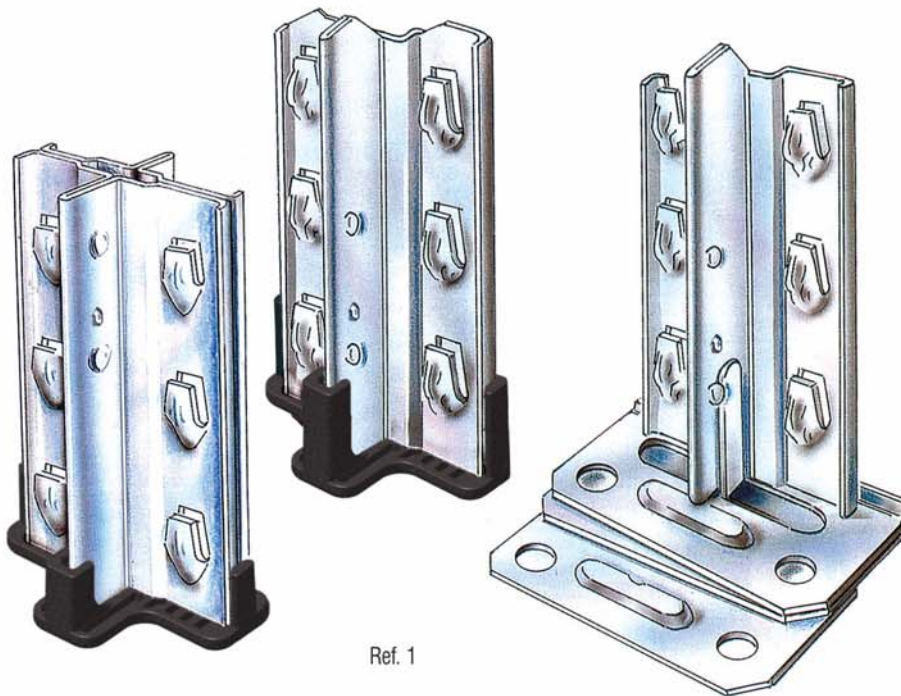

Ref. 1



Ref. 1b



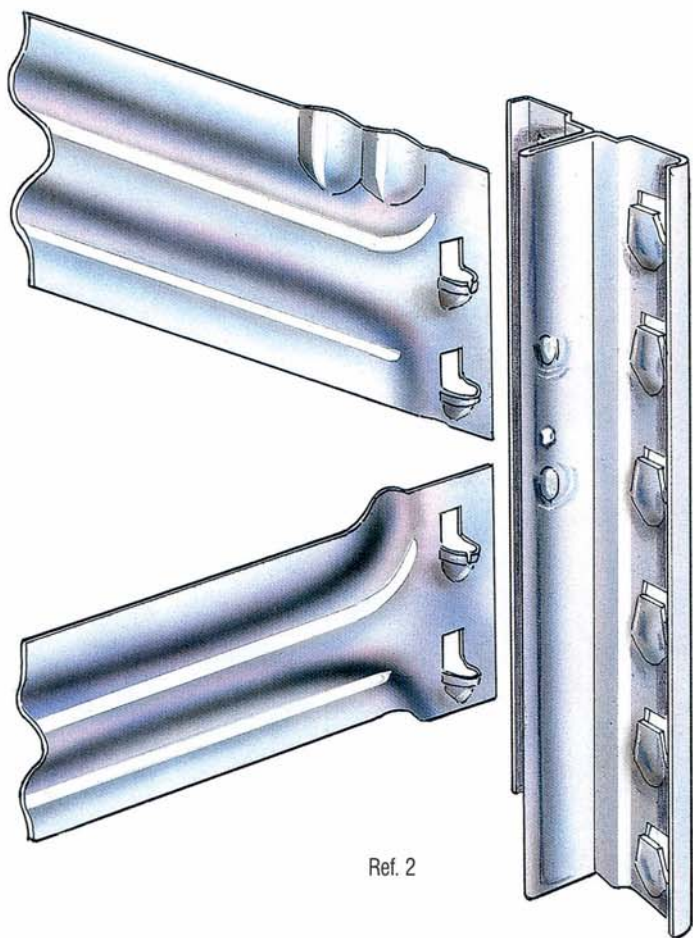

Ref. 2

Beams

Take the frames, assembled with bracing and base plates: keep them as perpendicularly as possible and fit the beam by tapping it down onto the tongues, close to the upright, with a plastic-faced hammer to avoid damage to the beam (Ref. 3).

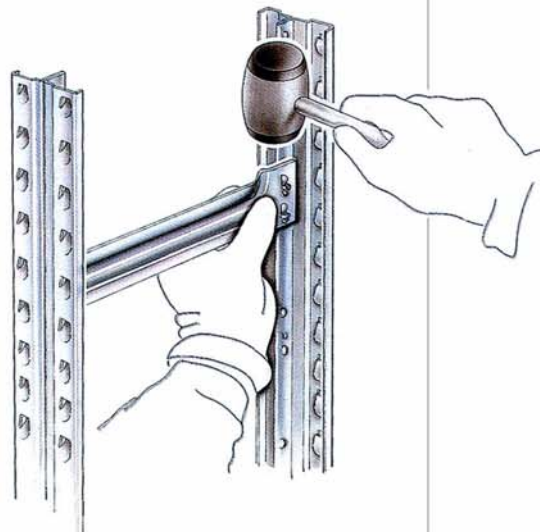

The beams, once assembled, should be secured with the respective beam locking pins (see page 21, Ref. 22).



Ref. 3

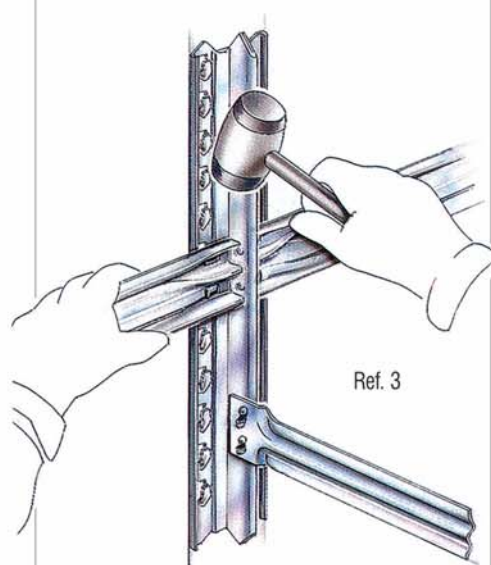

Ref. 3

For the storage of tyres or round materials which are placed directly onto the beams, plastic strips are available to avoid damage to the products stored; these strips are fitted into the recess of the beams (see page 21, Ref. 21).



Corner Solutions

Corner solutions allow for the best possible use of available storage space, especially within small and awkward rooms.

By means of 4 dedicated brackets, both left and right sided corners can be created without the need of inserting additional frames which would hinder full access to the shelving levels.

"T"-shaped peninsular configurations may also be created by coupling left and right sided beam connection brackets. With appropriate consideration, this application may also be used to close off end corridors of 2-tier-installations.

Applications are limitless!

For a correct layout, load bearing capacities and technical specifications referring to corner solutions, please refer to page 53 of this brochure (Ref. 67).

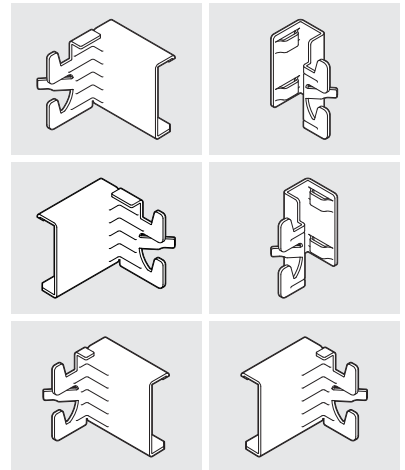

Shelves H12 and H25

Shelves of profile 12 mm, 450-600-900 mm wide, are produced in depths varying from 320 to 700 mm. Shelves of profile 25 mm and 300 mm wide are supplied in depths varying from 400 to 800 mm (Ref. 5-6).

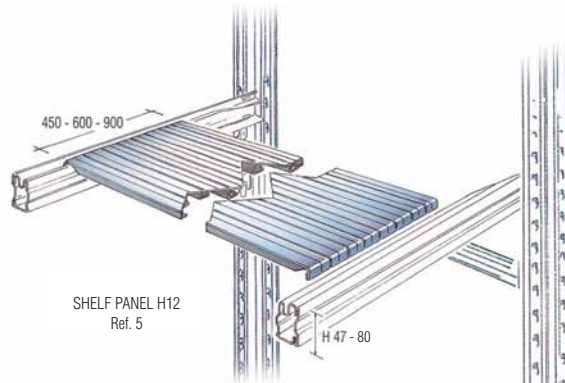

SHELF PANEL H12
Ref. 5

Perforated Plastic Shelf Panels

The standard range of perforated plastic shelf panels in 150-200-300 mm width is made from high quality polypropylene according to the RoHS directive, suitable for use within the food sector and RoHS compliant. The shelf panels are perforated at >50% of their surface.

Available in six different colours: white, yellow, light blue, blue, dark green and black, for frame depths 320-400-500-600 mm.

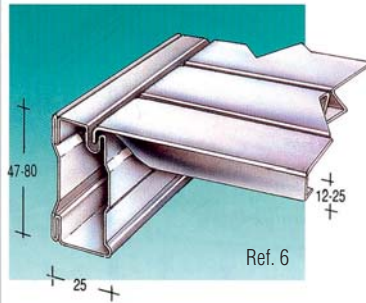

Ref. 6

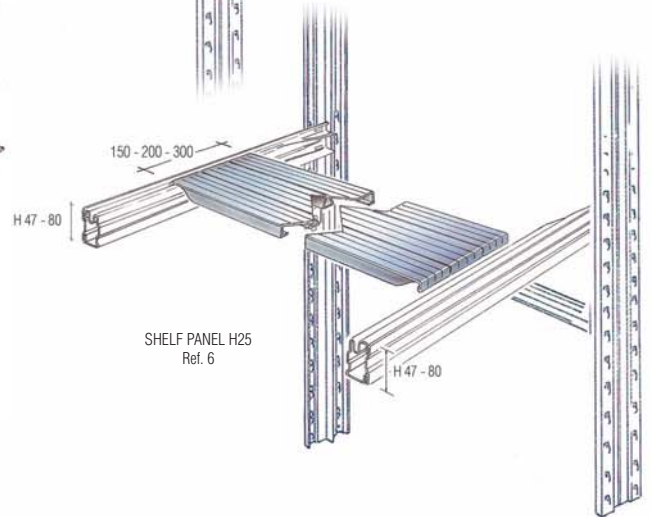

SHELF PANEL H25
Ref. 6

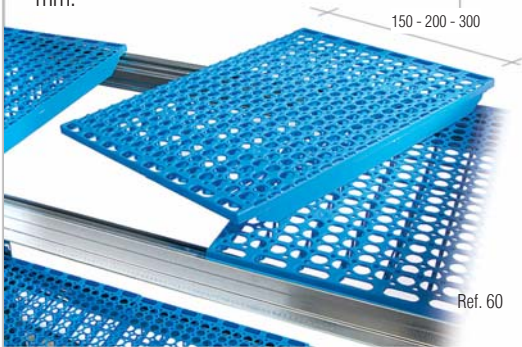

Ref. 60

Specific FROST shelf panels in light green colour are also available for use within cooling rooms. For correct ordering and load bearing capacities, please refer to page 46 and 47 of this brochure.



See page 11 and page 46/47

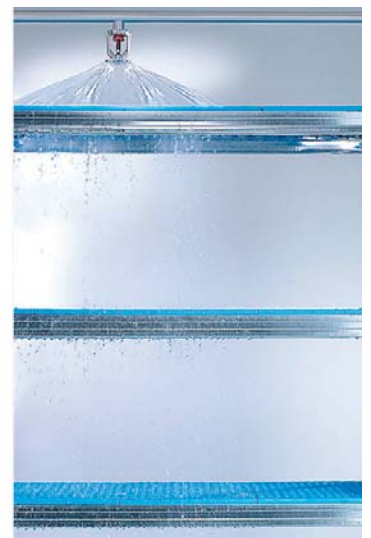

Perforated Steel Shelf Panels

Perforated steel shelves of profile 25 mm in 300 mm width, perforated at 50%. For installations equipped with sprinkler systems. Hole diameter 6.5 mm. For correct ordering and load bearing capacities, please refer to page 44 of this brochure.

Chipboard Shelves

Chipboard shelves of thickness 12 or 18 mm can be fitted using the clips shown below (Ref. 8).

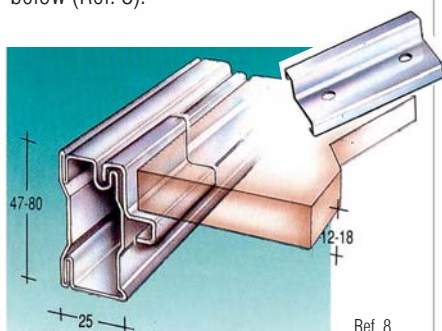

Ref. 8

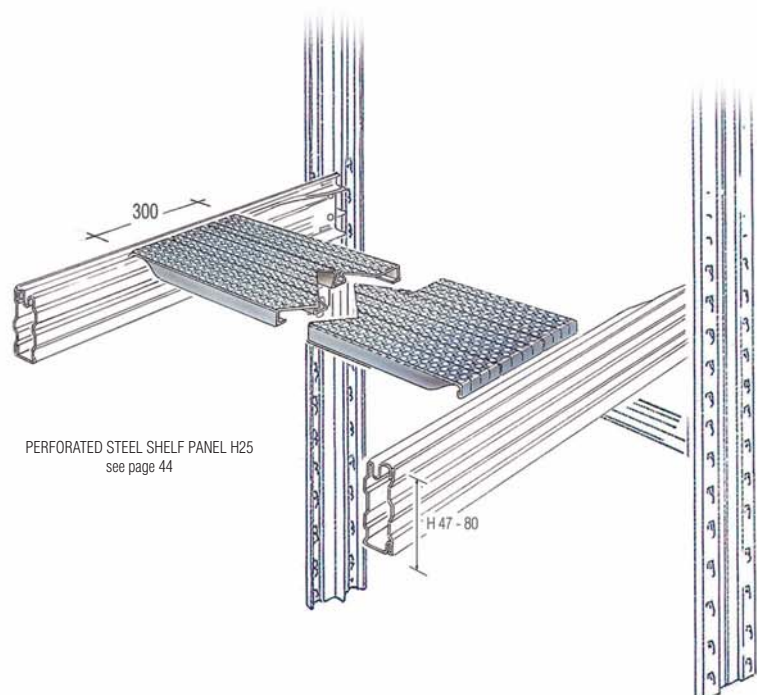

PERFORATED STEEL SHELF PANEL H25
see page 44

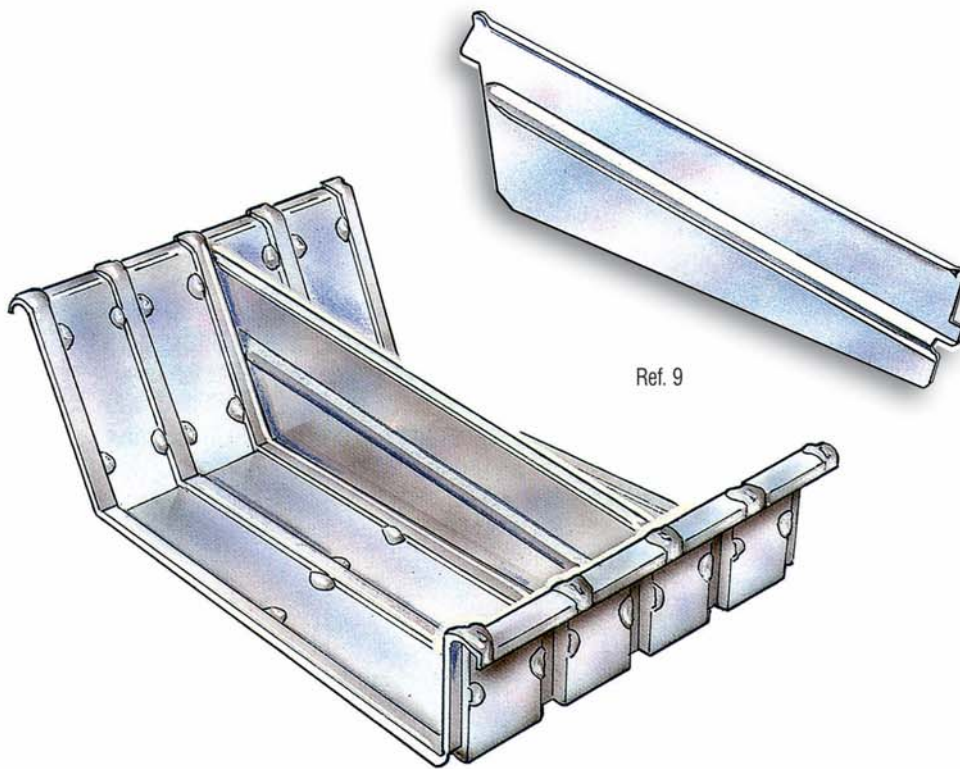

Ref. 9

Modular Containers

Insert the containers from left to right, and join them together by overlapping the beginning of the following container onto the end of the preceding one, pressing them into the recess of the beams.

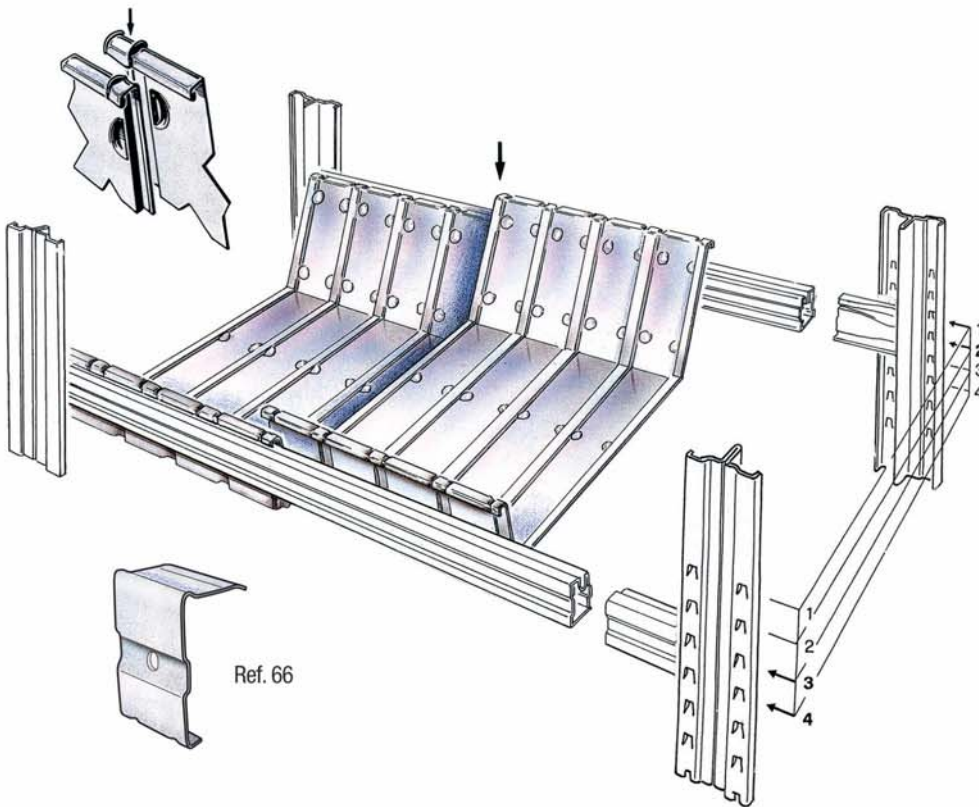

Ref. 66

Fastening Clip for Modular Containers

This clip prevents the modular containers from being accidentally unseated from their position (Ref. 66). Skip the first container to the left of the bay and fix each of the following modular containers using a pair of clips positioned on the second rib at the front and at the back of the container.



Ref. 66



Ref. 66

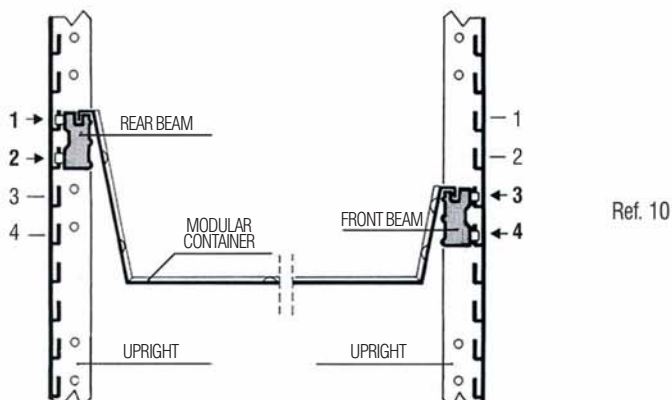

Ref. 10

To assemble the containers correctly, the rear beam should be fitted two pitches higher than the front one (Ref. 10). Fit the dividers into the special slotted seats, pushing down to locate (Ref. 9).



The capacity of the containers can be increased by fitting bin front and rear panels 200 or 300 mm high.

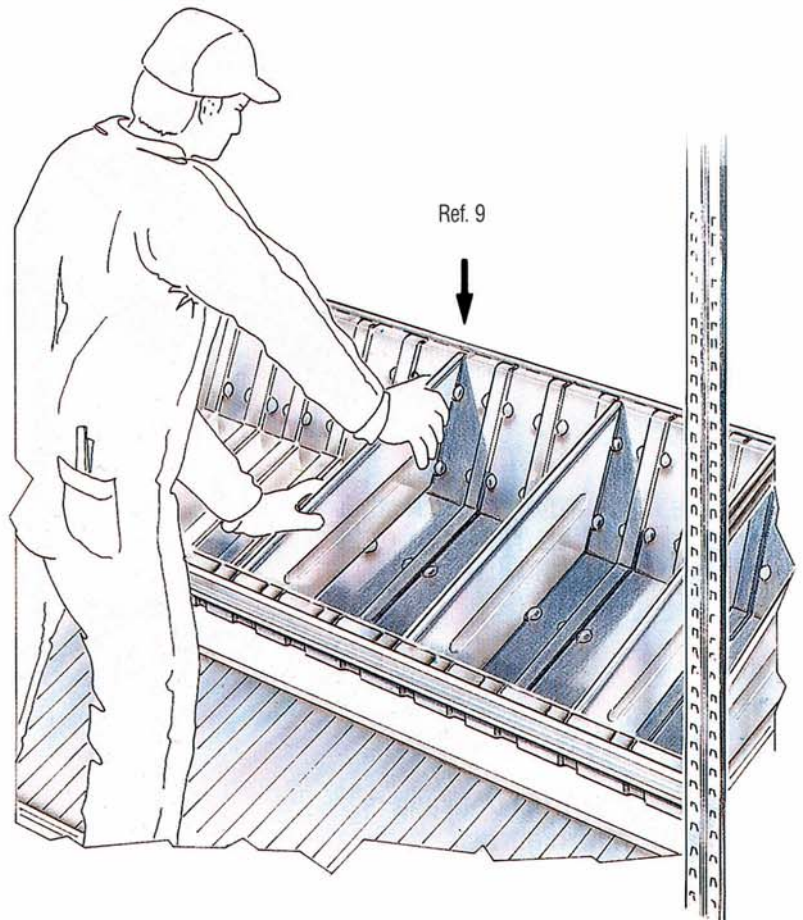

DIVIDERS

A large range of dividers is available.

Vertical Sliding Dividers

These have been designed to separate boxed items (Ref. 11). The concept of these dividers is based on the following components: a pair of clips, left and right, and vertical dividers, available for all frame depths and in two different heights (H100 mm / H200 mm), as well as in trapezoidal version (H200/100 mm).

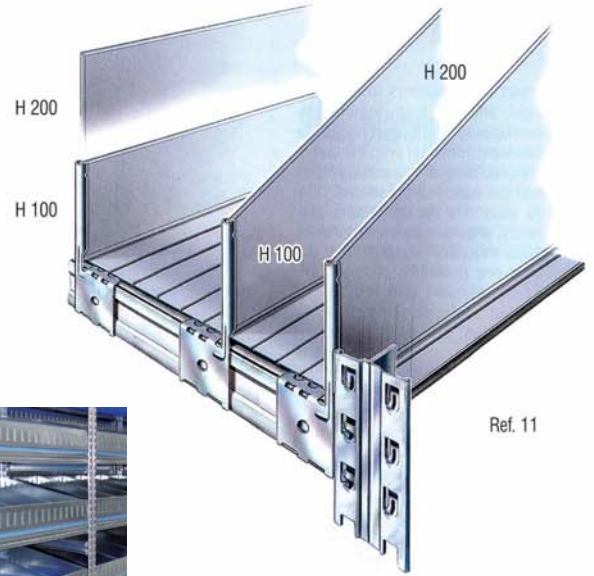

Shelf Trays

These comprise of a bin front and rear panel 100 mm high placed on a normal shelf with adjustable dividers from 320 to 800 mm in depth (Ref. 13).

Modular Drawers

The modular drawers are fully integrated with the Super 1-2-3 series and are located directly on the frames.

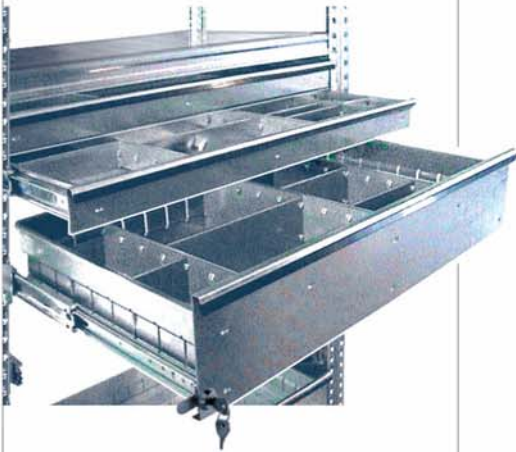

The drawers provide a cost effective solution for the storage of small items and may be fitted with a key lock.

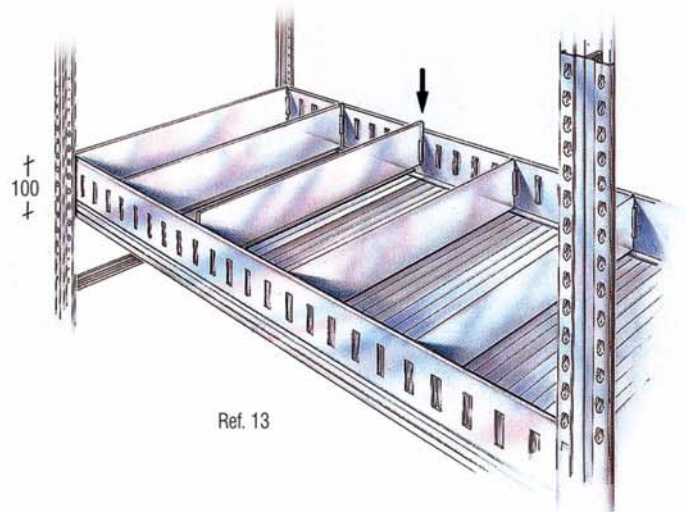

Bin front panels 100 mm high and rear panels 200 mm high are fitted with trapezoidal dividers (Ref. 14/15).

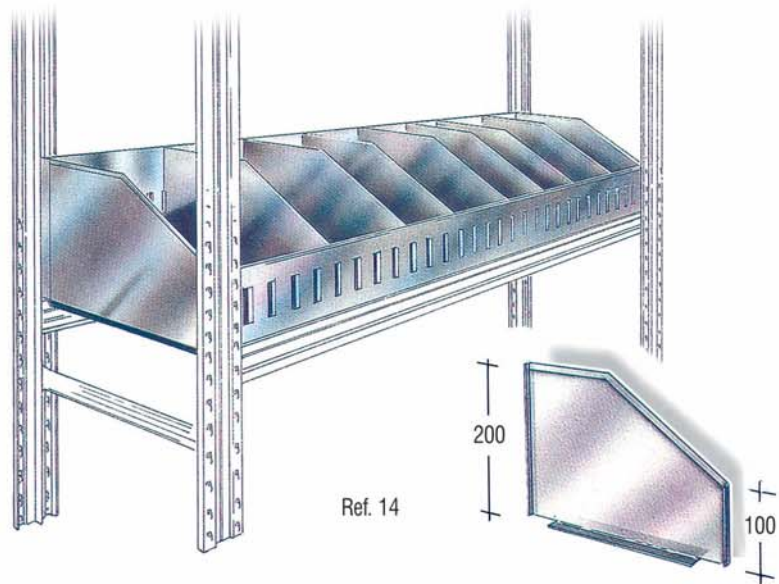
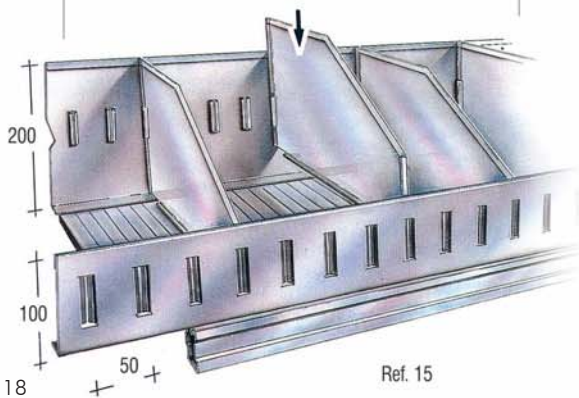



Plastic Line

Open fronted plastic bins are also available for the storage of loose items. More information on page 55.

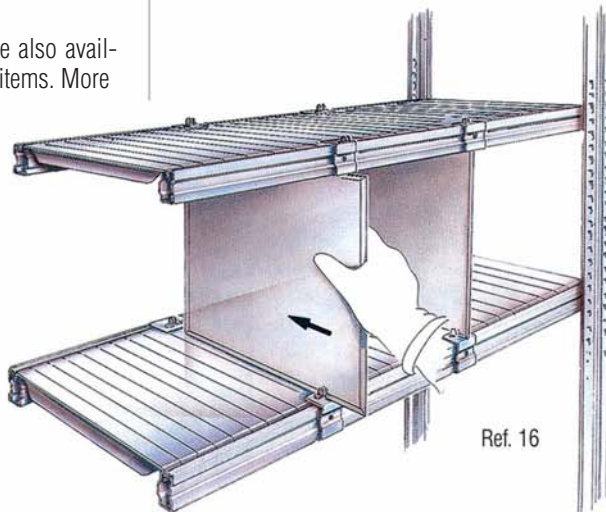

Fixed Height Dividers

Available in three different heights: 244-344-444 mm. They can be inserted in any position on the shelf by means of spring clips located on the beams H47 (Ref. 16).

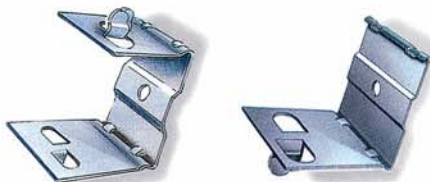



Telescopic Tube Dividers

Used for the separation of cylindrical components or materials difficult to store (windscreens and panels, etc.). They comprise 2 tubes of 18 mm diameter sliding one inside the other. They are fixed to the upper shelf by means of a clamp/screw connection (8mm). A minimum of two tubes should be used for each division (Ref. 17).

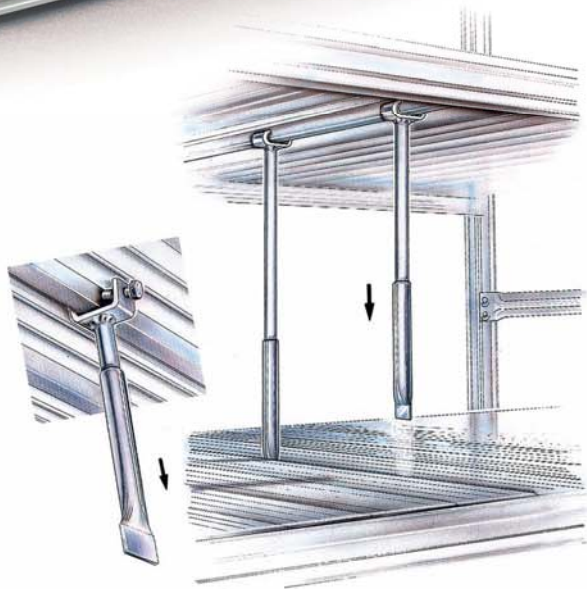

Ref. 17



Dividers for Exhaust Pipes

Spigots designed for the separation of tubes, exhausts and conduits, etc. Dividers for exhaust pipes are supplied for both vertical and horizontal divisions fitted directly to the beam (not to be loaded) (Ref. 18).

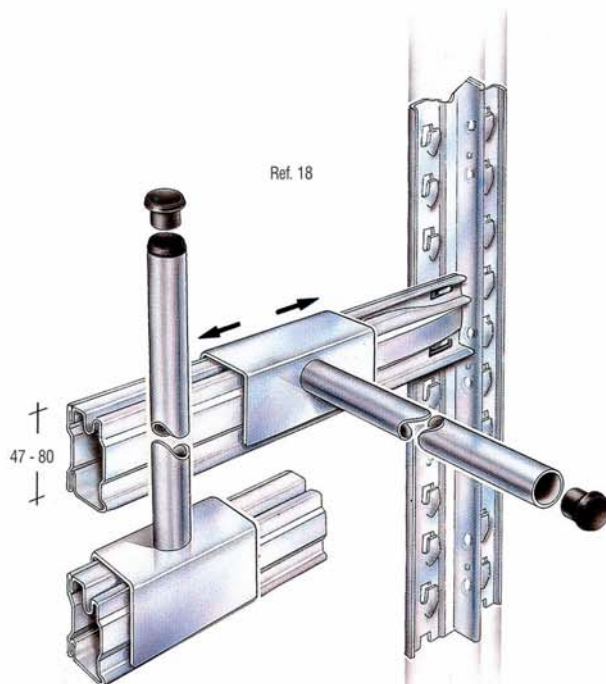

Ref. 18

Label Holder

It can be located in any position on both H47 and H80 beams. Dimensions 100x40 mm (Ref. 23).

ACCESSORIES

PVC Top Caps

PVC top caps are to be fitted onto the top of the upright, in all applications (Ref. 20).

Oval shaped Tubes and Beams

The oval shaped beams and tubes are compatible with most types of hooks and provide a cost effective solution to garment storage and for hanging loads (Ref. 19/20). The garment hanging shelving can be designed on a single or double entry basis and equipped with shelves. The oval tubes fitted onto the spacer bars alone will not stabilise the structure in the horizontal plane and have to be combined with beams above and below.



Tyre Storage

The oval shaped beams can also be used for the storage of tyres (see page 10).

In this case, please refer to the technical handbook to identify correct use and appropriate load capacities.

In the case that the tyres will be stored on H47 mm beams, it is obligatory to use the Super 3 version only and exclusively, both for the beams and the frames.

Maximum allowed bay length: 1200 mm.
Maximum allowed frame depth: 400 mm,
to ensure safe storage and to prevent torsional deflection of the beams.

Plastic Strip for Glass Shelves

It can be fitted on the beams in order to protect glass shelves or delicate materials (Ref. 21).

Security Pins

In order to prevent accidental lifting of the beams and shelves, the security pins should be used in all applications (Ref. 22). Assembly instructions as per the sketch at right.

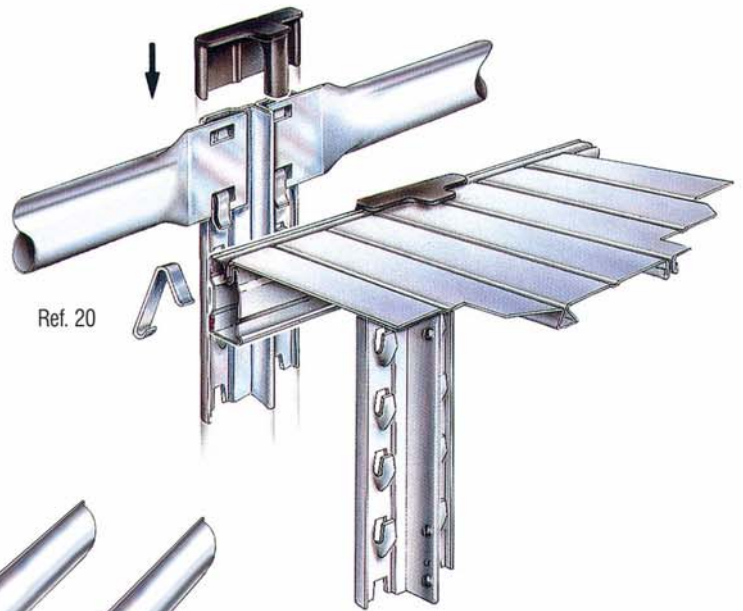

Ref. 20

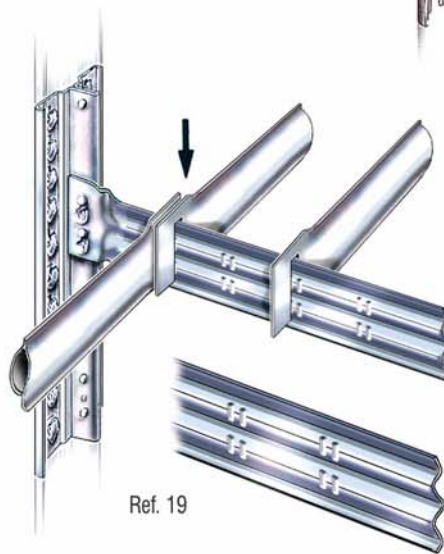

Ref. 19

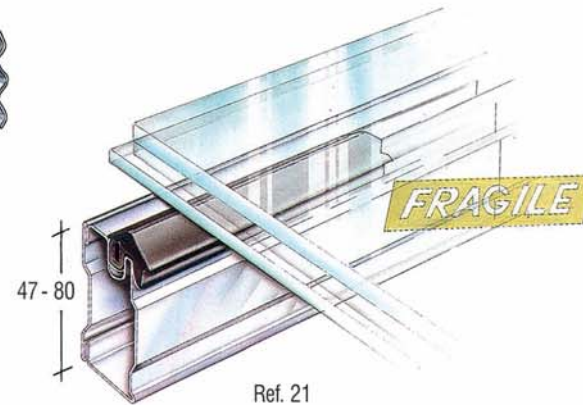

Ref. 21

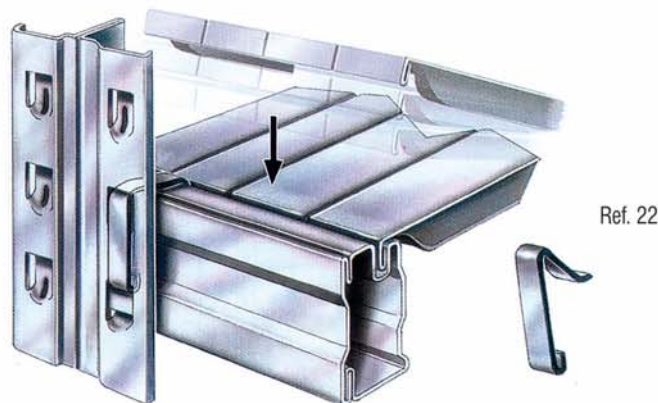

Ref. 22



Ref. 23

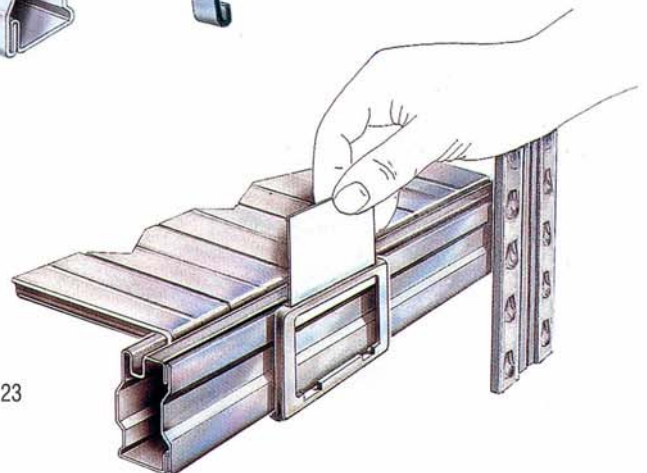

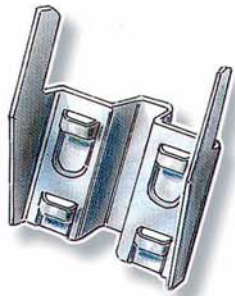
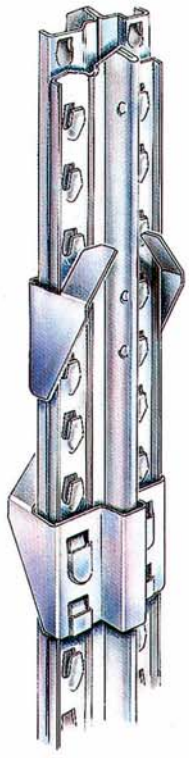

Ref. 24

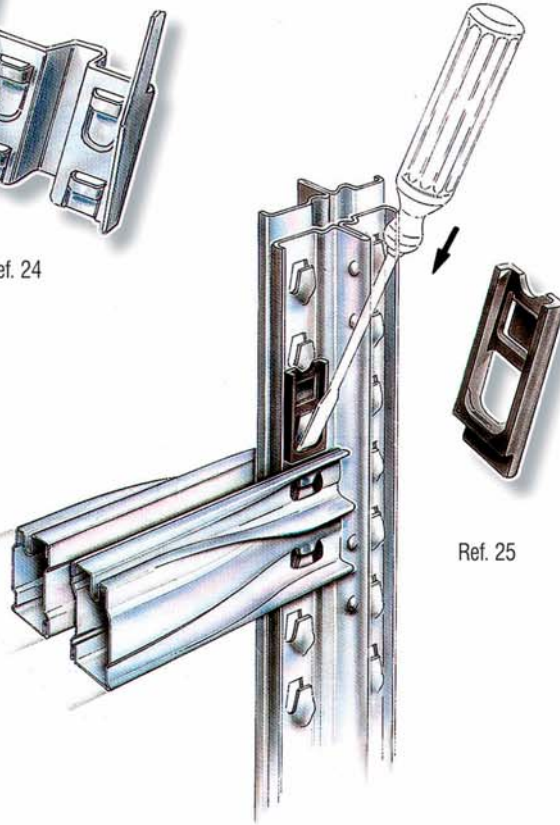

Ref. 25

Frame back-to-back Clips

They are used to fix the frames together when building back-to-back bays to improve stability. They are located at mid height (Ref. 24).

Security Pins for Beams in back-to-back Bays

They are used to prevent accidental lifting of the beams when building back-to-back bays (Ref. 25).

Fastening Clips for Shelf Panels

These fastening clips are an optional accessory, used to prevent shelf panels from being accidentally unseated from their position. They may also be used as a locking mechanism for the shelf panels to be firmly kept at a given position or at a distance to achieve 50% opening of the surface or alike. The clips press the shelf panels against the beams providing the added benefit of stiffening the entire system. They are assembled by hand and can easily be disassembled with the aid of a flat-bladed screwdriver as shown in the pictures (Ref. 66). Please refer to METALSISTEM Informa n° 672 for additional information.



Ref. 66



Ref. 66

CLADDING END PANELS H25

End panels H25 are manufactured in two standard sizes (200-300 mm wide) and in standard heights of 14485-1940-2480-2980 mm (Ref. 26). End and middle joints are also available to build multiple cladding heights and/or to finish off the cladding panels at their upper end (Ref. 31). In case of the cladding panels being lower than the respective frame, "H"-section profiles may be used at the bottom of the cladding panels, to achieve equal height (Ref. 31).



Ref. 26



In case of the panels being lower than the respective frame, "H"-section profiles may be used at the bottom of the panels, to achieve equal height (Ref. 31).



Punched hole panels H25 are also available, according to European Standards (i.e. hole diameter of 5 mm, at 25 mm centre distance).

Special clips are used to fasten the cladding panels. For end panels it is the clip art. code n° 68107.95 (Ref. 28), for back panels H29 mm it is the clip art. code n° 68108.95 and for back panels H12 mm the clip 67010.95 (Ref. 27).

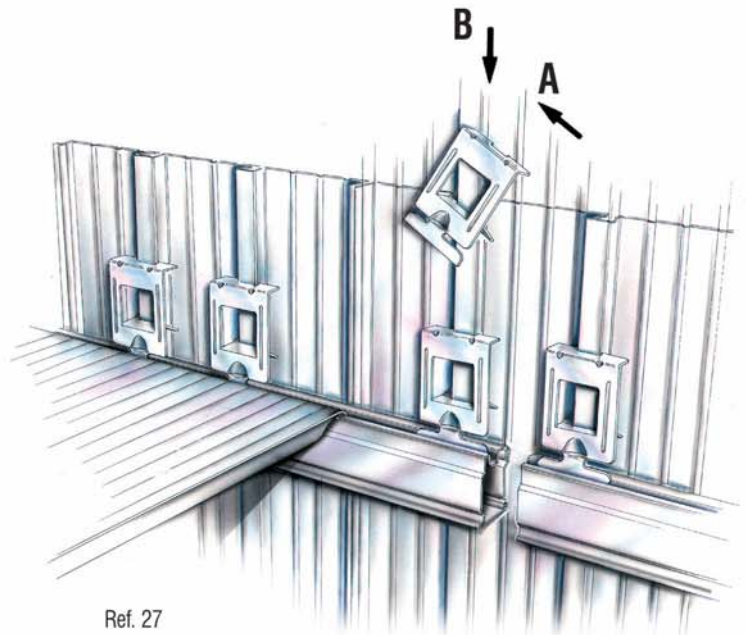
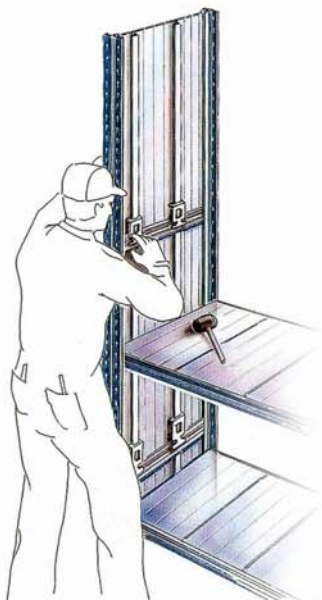

Ref. 27

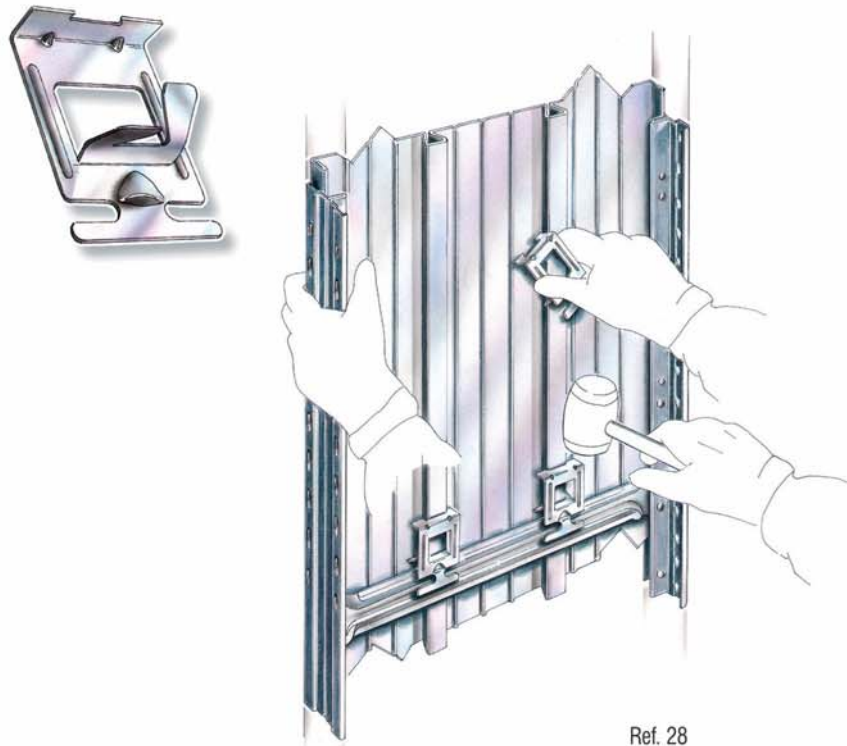

Ref. 28

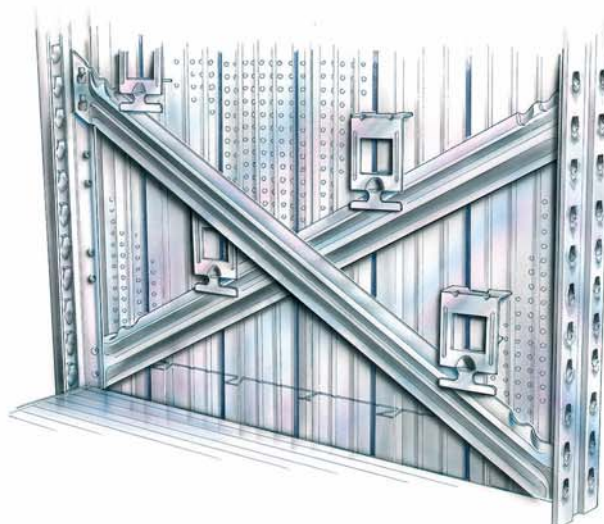

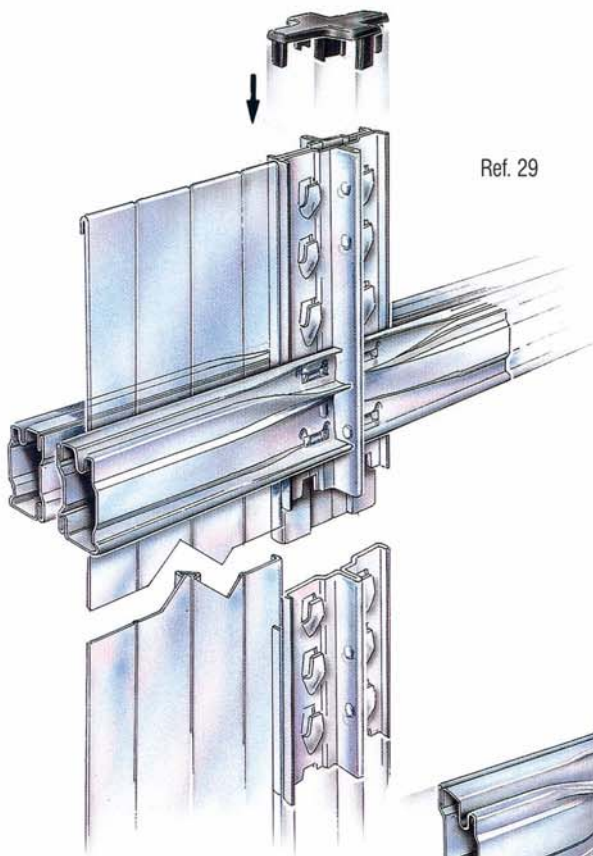

Ref. 29

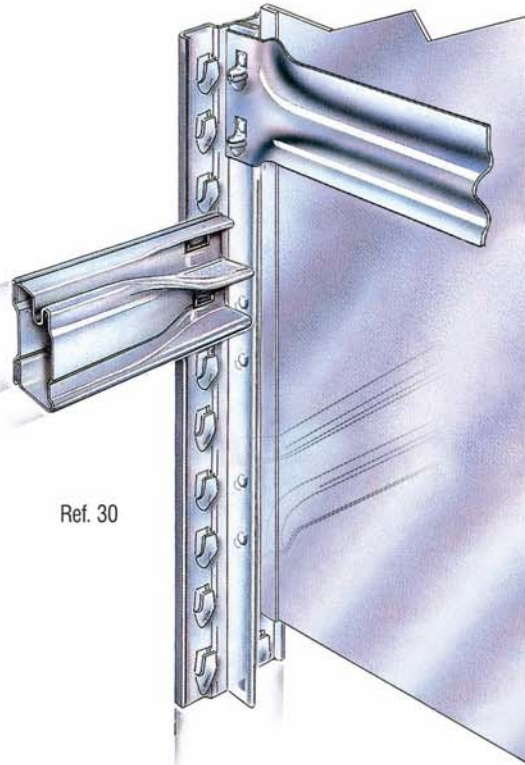

Ref. 30



Ref. 31

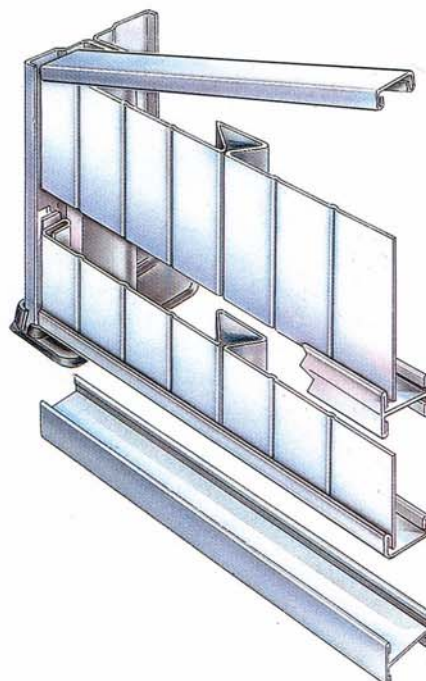

Side Cladding

This type of cladding may be used to enclose individual bays within shelving runs. Available for frame depths up to 600 mm. Side cladding panels are fitted between the diagonal spacer bars of the frames. When ordering side frame claddings, the respective frames are to be built with diagonal spacer bars only, i.e. the horizontal spacer bars have to be replaced with diagonals (Ref. 30).



MODULAR SLIDING GATE

The modular METALSISTEM sliding gates are supplied preassembled, in kit form. Two different models are available: with guide rail assembled on the ground or with external, suspended guide rails, made from a USP upright profile supplied in standard lengths of 4500 mm which has to be cut to size on site according to individual needs. For available dimensions and ordering, please refer to page 50 of this brochure.



Cladding BACK PANELS H12 mm for back-to-back Bays

Back panels H12 are manufactured in 450-600-900 mm standard width and in standard heights of 1485-1940-2480-2980 mm (Ref. 29). When using H12 mm panels within back-to-back bays, the single modules are superposed at the center of the bay (see sketch below). The cladding modules are kept in position by the beams of the back-to-back bays. For multiple cladding heights, a couple of beams has to be located at junction points (Ref. 31).

The sketches shown below and beside explain the design and assembly of the various cladding components.

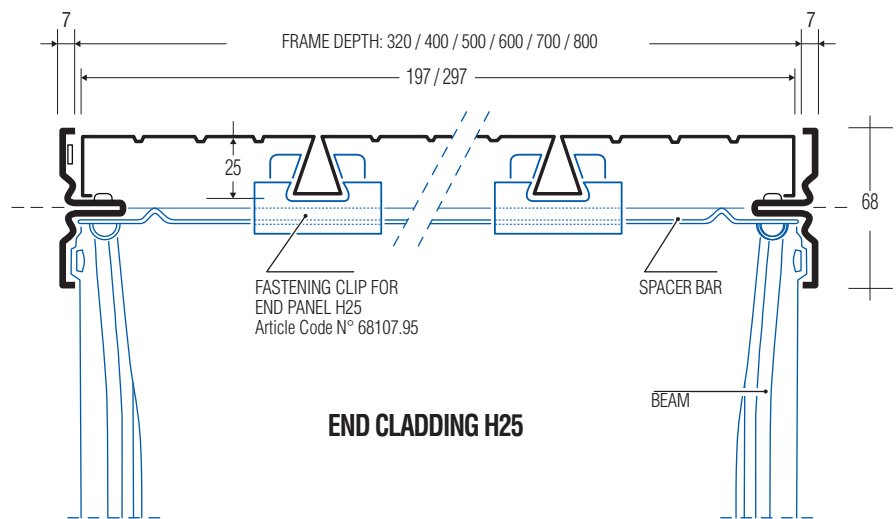

BACK CLADDING H12 for single sided rows

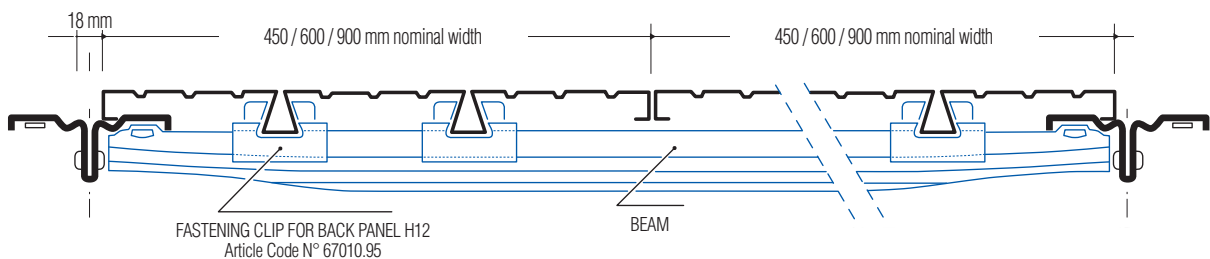

BACK CLADDING H12 for back to back bays

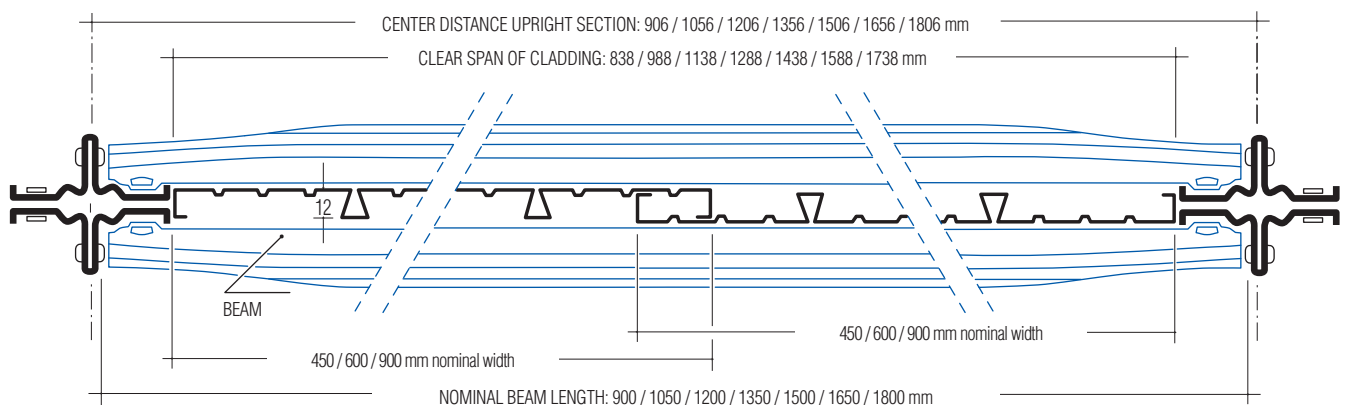

Super 3 Two-Tier-Structures with suspended walkways (max. load bearing capacity = 300 daN/m²)

Two tier structures, even varied and complex have been designed by METALSISTEM combining light weight with high strength in the METALSISTEM tradition, avoiding any type of bolting or welding.

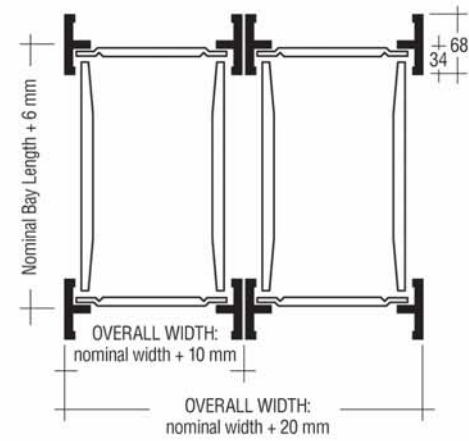

When designing two tier structures, consider the dimensions and details of the sketch shown above. Always refer and adhere to the calculation and safety code summarized on pages 4 and 5.

Max. shelf bay length: 1500 mm
Max. width of walkway: 1200 mm

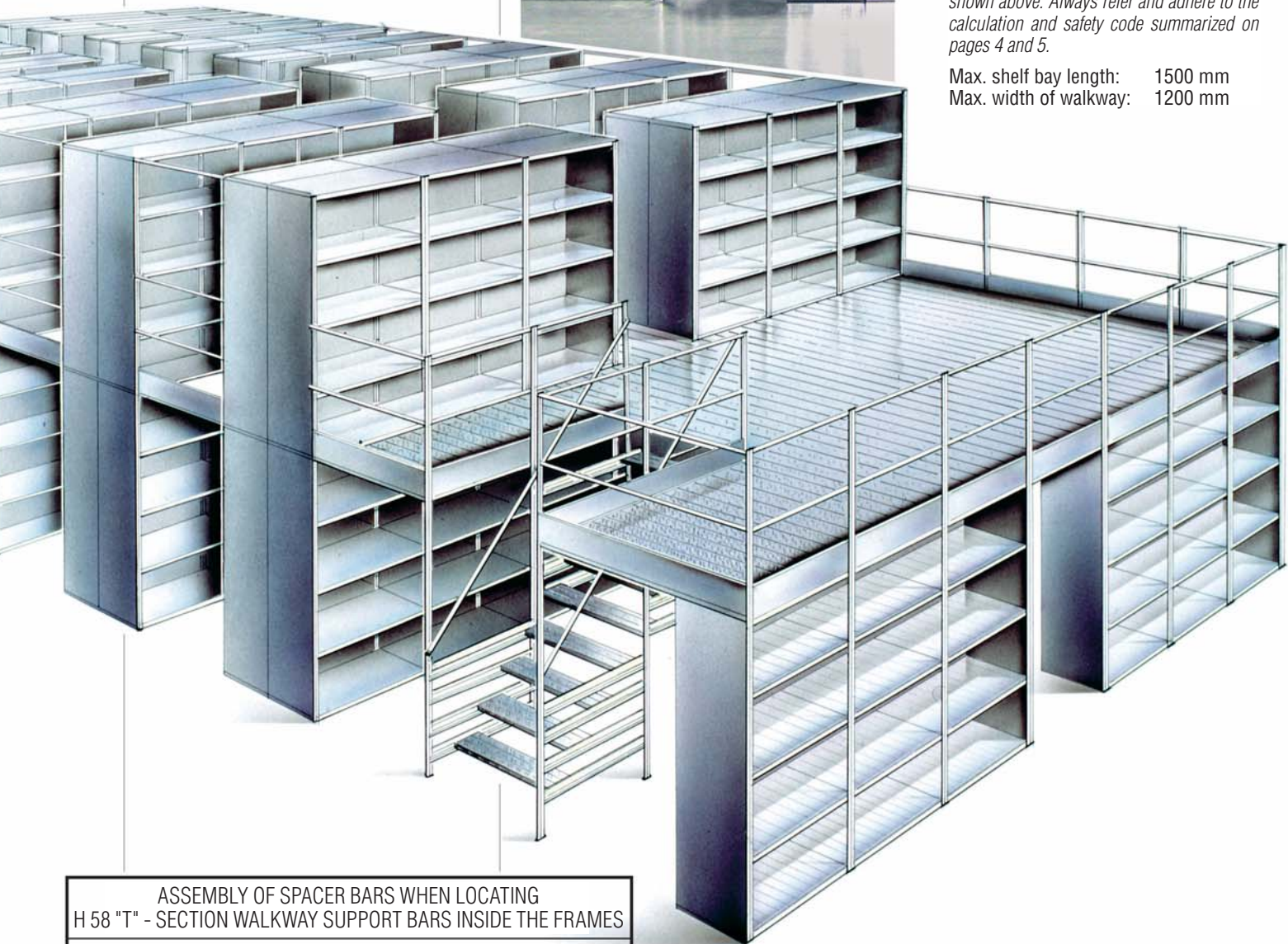

ASSEMBLY OF SPACER BARS WHEN LOCATING H 58 "T" - SECTION WALKWAY SUPPORT BARS INSIDE THE FRAMES

L 900 : NO SPACER BAR

L 1200 : ONE SPACER BAR AT THE CENTRE

L 1500 : ONE SPACER BAR AT THE CENTRE

NOTE:

- The spacer bars connecting the "T"-walkway support bars must be ordered in a special length (10 mm narrower than those used to assemble the standard frame).
- When building staircases, customers should fit one spacer bar under each stair tread.

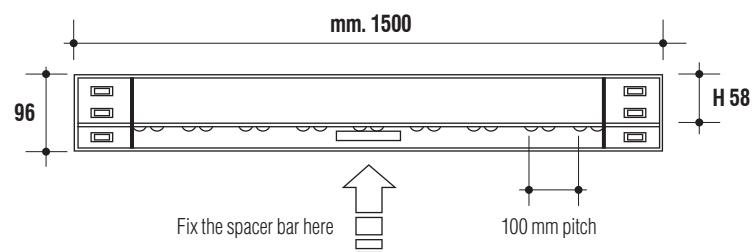

Steel Planks

These can be supplied with three different surfaces: ribbed, open and smooth, together with compensation panels and fastening components. The steel planks are inserted into the "T"-section supports by levering between the panel and the support (Ref. 32). There are two types of steel planks: one for walk-through bays and one for walkways. When ordering, always refer to the length of the respective spacer bar used for building the walkway or the frames (see page 48).

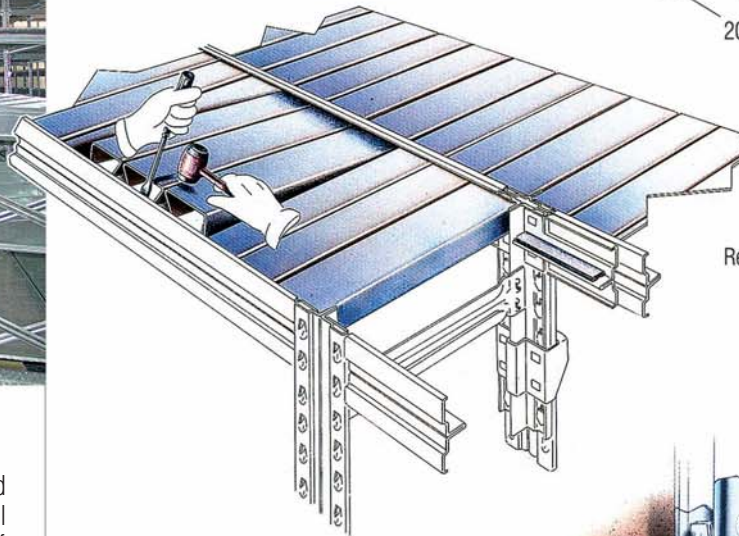
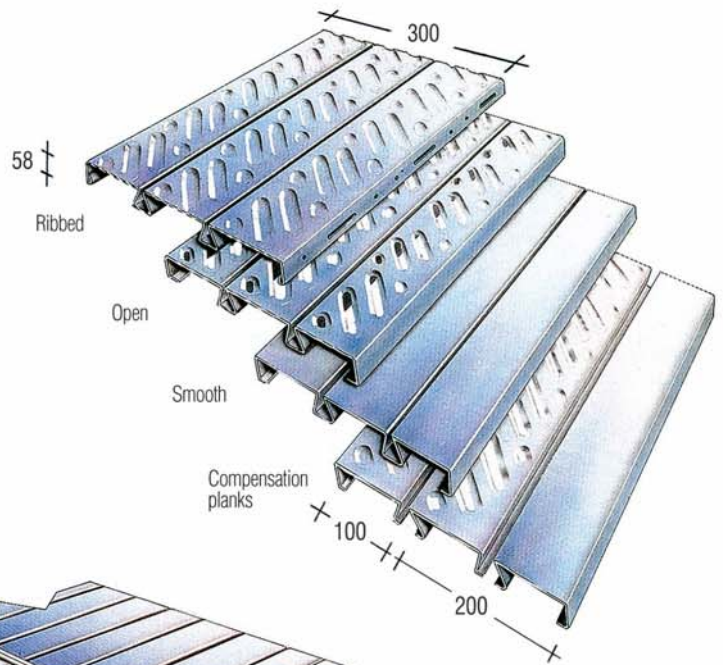

"T"-Section Support Bracket - at 90°

"T"-Section support bars can be located at 90° by assembling one half of a wall fastening bracket (art. n° 65022.95 - Ref. 34) and one half of a "T"-section support bracket (art. n° 67022.95 - Ref. 33). Wall fastening brackets are also available, similar to the above, providing a method to fix the frames to a wall for stability (Ref. 34).

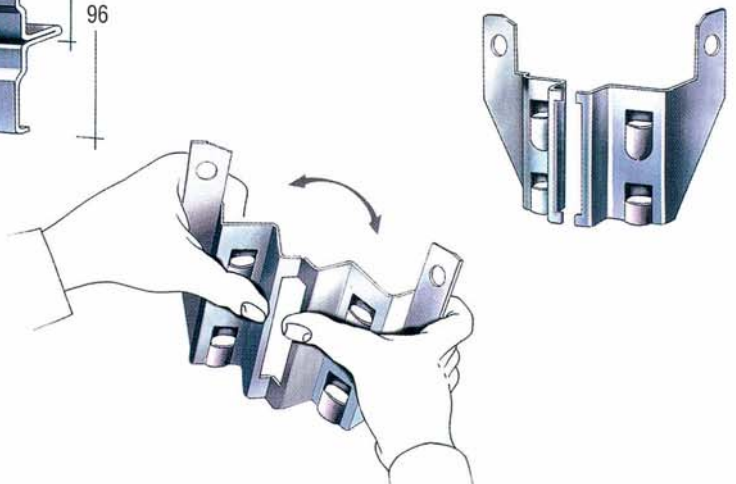
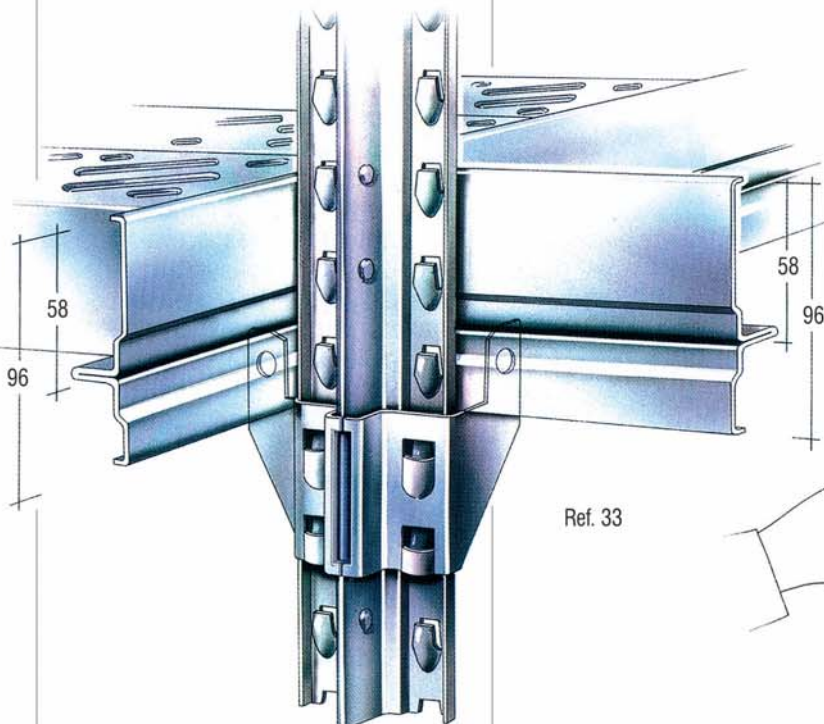
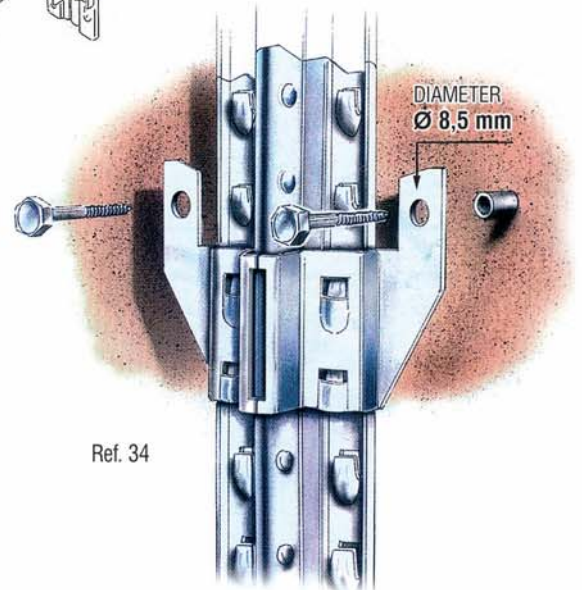

Assembly Instructions Super 3 Two Tier Structures

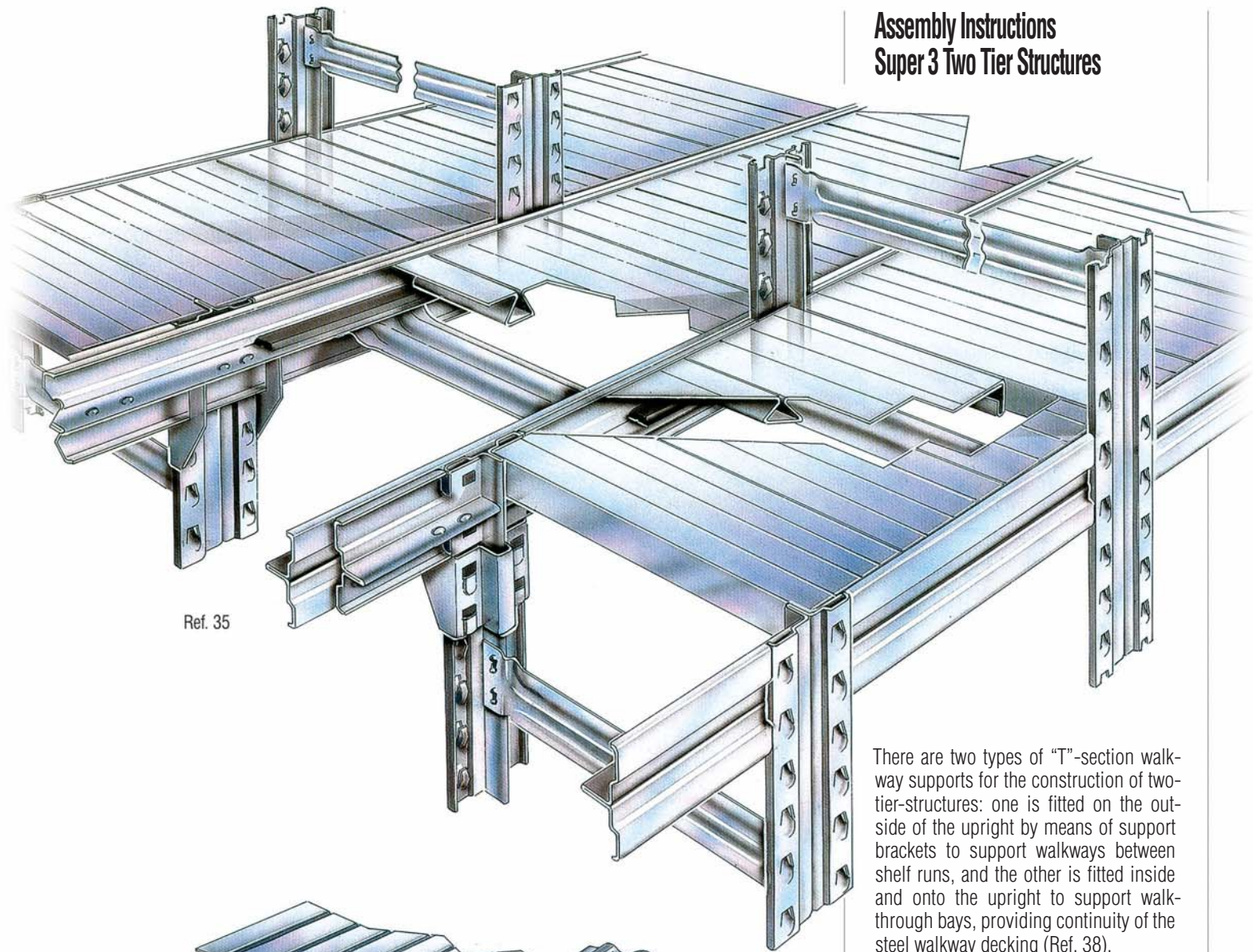

Ref. 35

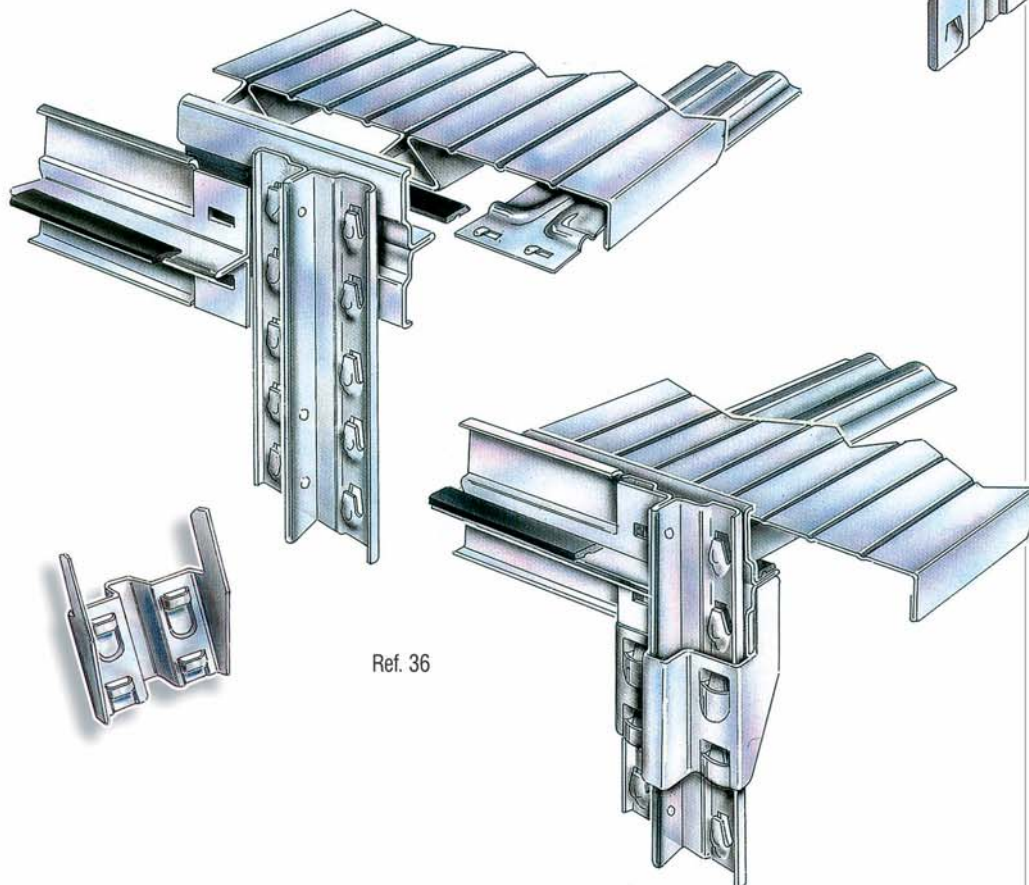

Ref. 36

There are two types of "T"-section walkway supports for the construction of two-tier-structures: one is fitted on the outside of the upright by means of support brackets to support walkways between shelf runs, and the other is fitted inside and onto the upright to support walk-through bays, providing continuity of the steel walkway decking (Ref. 38).

The nibs on the "T"-section walkway support beams H58 allow these beams to be connected between them by means of spacer bars being 10 mm narrower than those used to assemble the respective frame (Ref. 35). To reduce noise, a PVC strip is fitted between the steel planks and the "T"-section support bars (Ref. 37).

To achieve a correct assembly of the "T"-section support beams within walkways (art. n° 67015.95) these spacer bars must be located under the walkway support beams, at centre distances of 800 mm approximately (Ref. 35/36).

In order to avoid sharp edges, the "T"-section supports should be assembled with an overhang of about 2 cm and finished off with plastic top caps (Ref. 42).

For fixing back-to-back frames together use the two-tier support bracket, bending the tongues behind the second upright, as shown on Ref. 37.

When designing two-tier structures, remember that the overall width of every frame and every walkway will be about 10 mm more than the length of the spacer bar used. Also, when calculating the total length of runs, allow for approximately 6 mm of "creep" per bay (see page 26). When using any other type of flooring, it is important to note that the floor panel itself will be 4 mm narrower than the spacer bars used to assemble the walkways and respectively 12 mm narrower than the spacer bars used to assemble walk-through bays. In all cases, only Super 3 components should be used when designing two-tier structures.



See more on the web

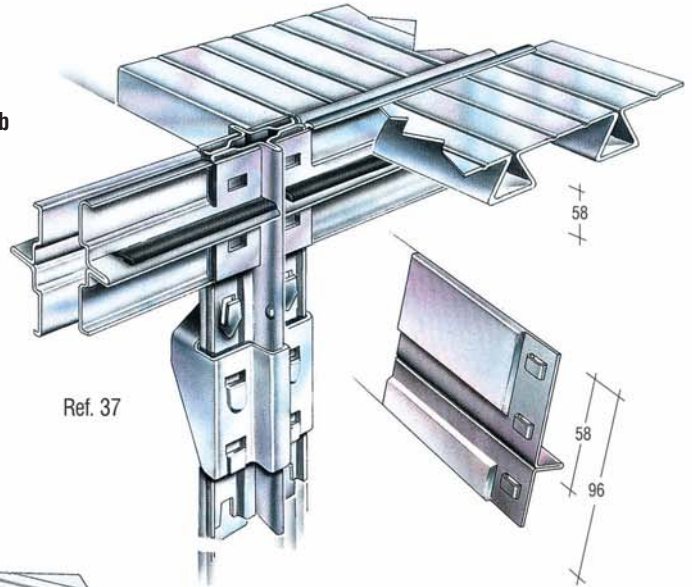

Ref. 37

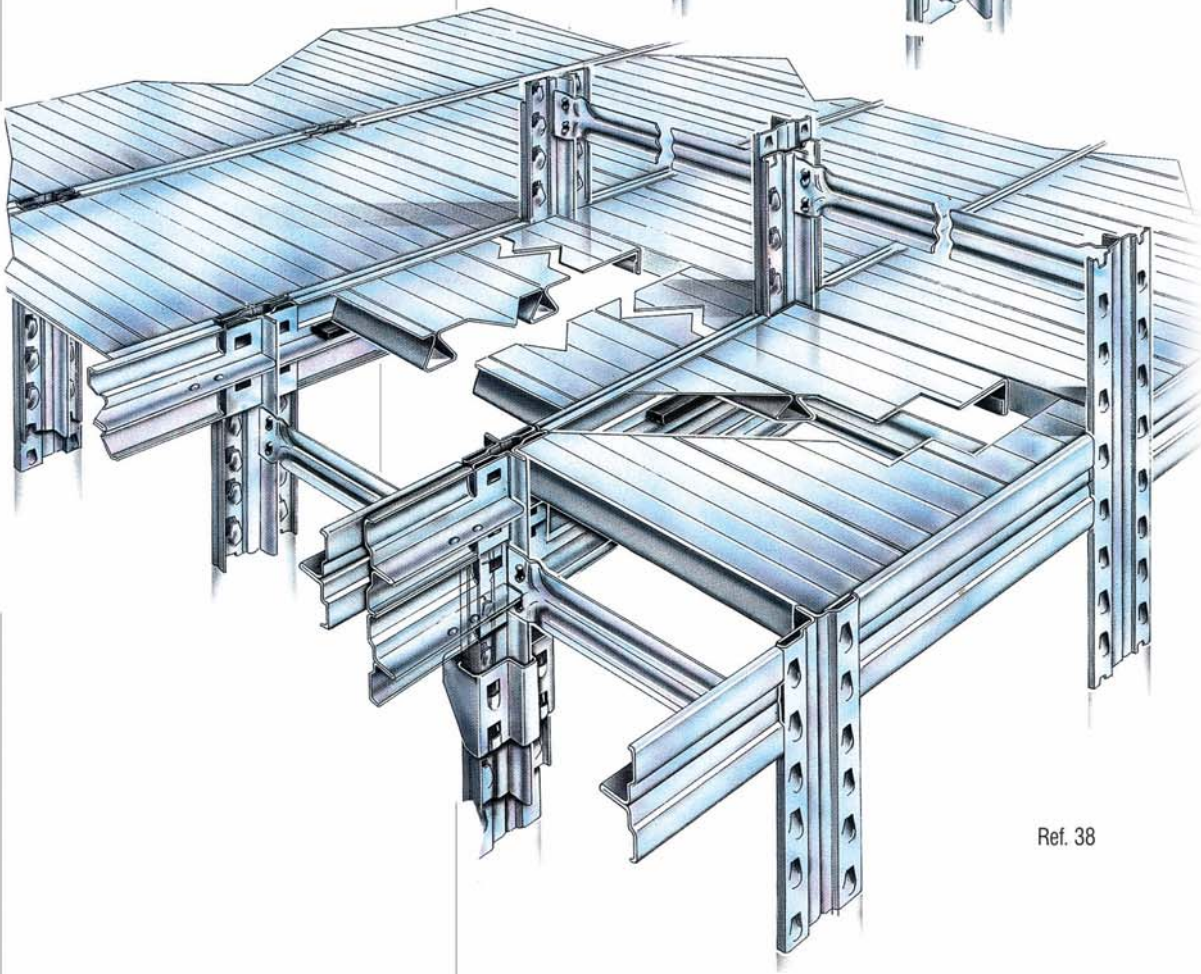

Ref. 38



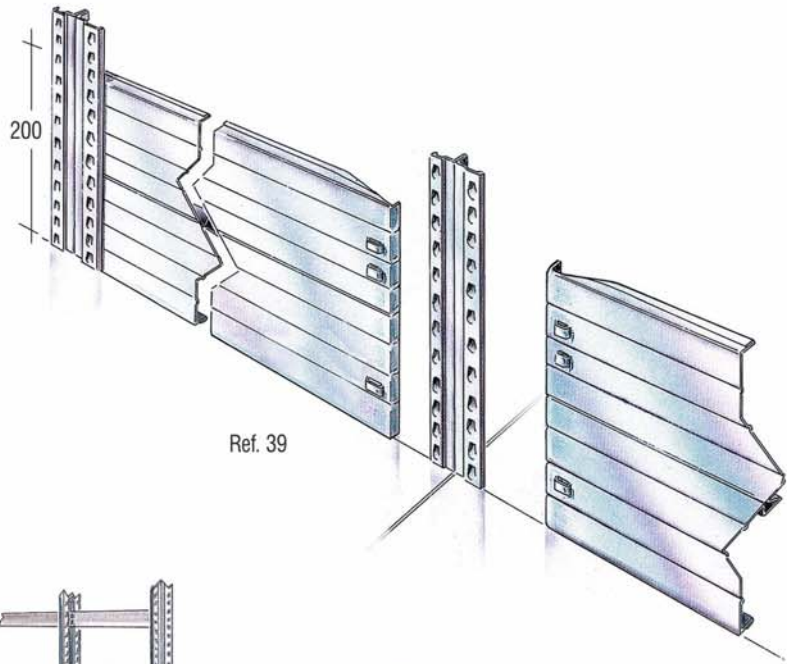

Ref. 39

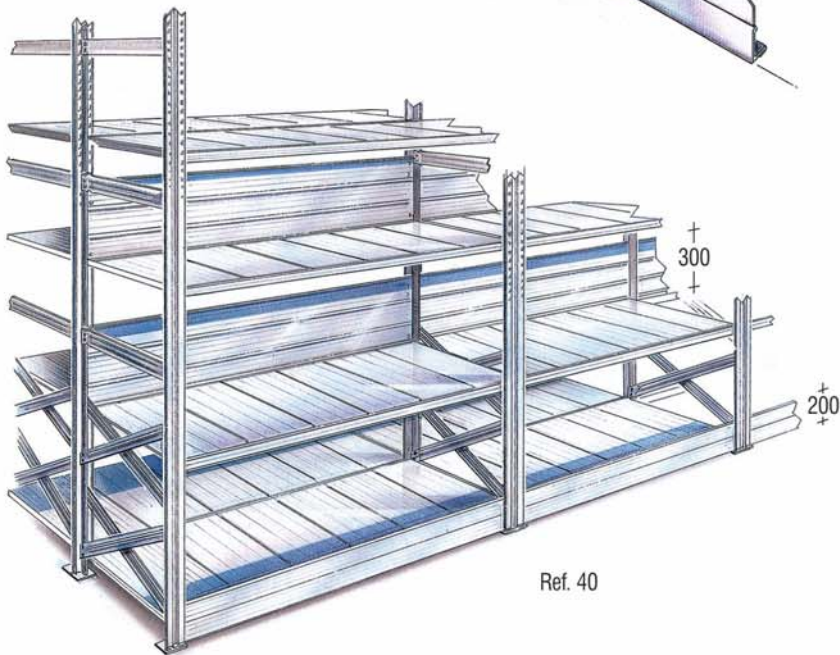

Ref. 40

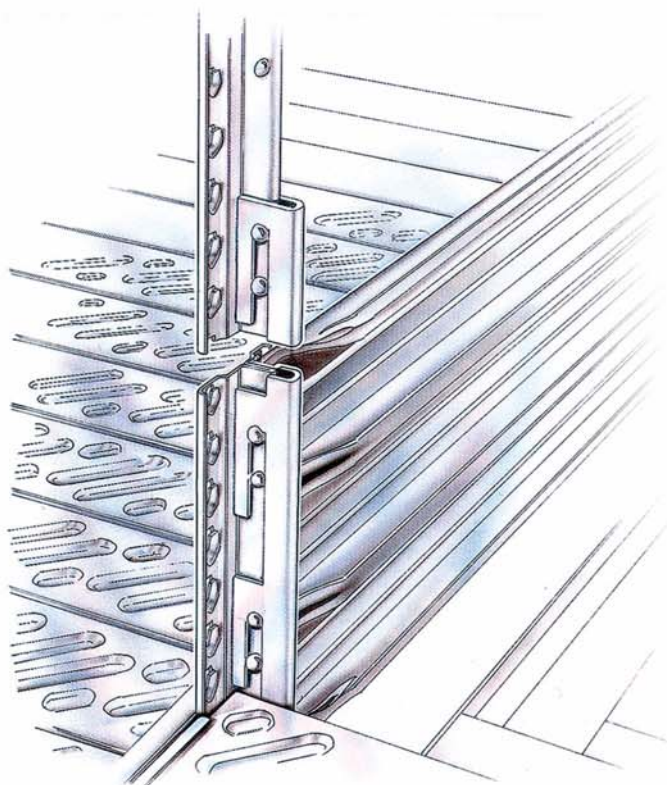

Ref. 50

Kickboards

Three different types of kickboards are available: for use in the direction of the beams, at the end of a run within uprights, or for walkway ends.

Kickboards are made from two oval shaped tubes (the same items used to build the handrails) fixed to the uprights and finished off with a metal sheet element located onto the oval shaped tubes by self tapping screws.

For correct ordering of these items and dimensions, please see instructions on page 50 of this brochure.

The use of beam retaining clips is mandatory.

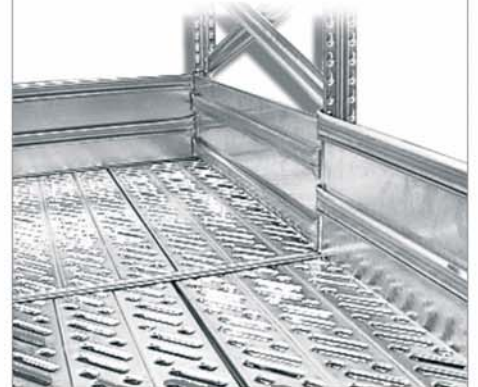

In the direction of the beams, shelf boards are available in two different heights, 200 or 300 mm (art. n° 64016.95 - 64040.95). These items have flanged ends with slots to be located onto the uprights (Ref. 39/40).

Upright Reinforcement

Uprights that are used as newel posts for handrail should always be fitted with the reinforcing brackets shown (Ref. 50).



Staircase Handrails

The handrail tube is a square profile in \varnothing 32x32 mm section, available in both stainless steel and zinc coated version. The fastening of the handrail onto the uprights is made by nylon components and brackets, as shown in the picture below (Ref. 45).

The necessary components have been included into a macro code, for easy ordering. Please refer to page 52 of this brochure.



Hand Rails

Hand rails and knee rails are made from oval shaped beams (Ref. 49). For correct ordering of these items, please see instructions on page 50 of this brochure.

The use of beam retaining clips and upright tops caps is mandatory.

Handrails on two-tier structures may also be built with "U"-Section profiles assembled in conjunction with special PVC supports (Ref. 47-48).

These supports can also be used to finish off the handrails at their ends.

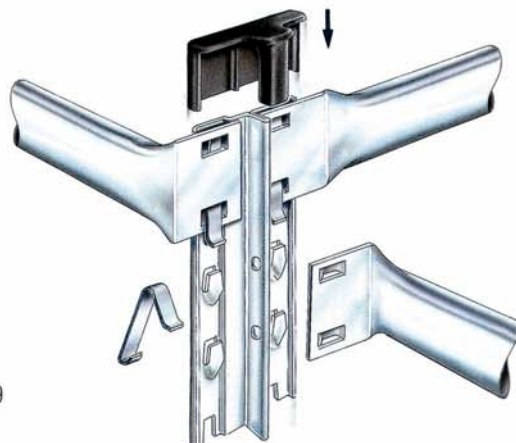
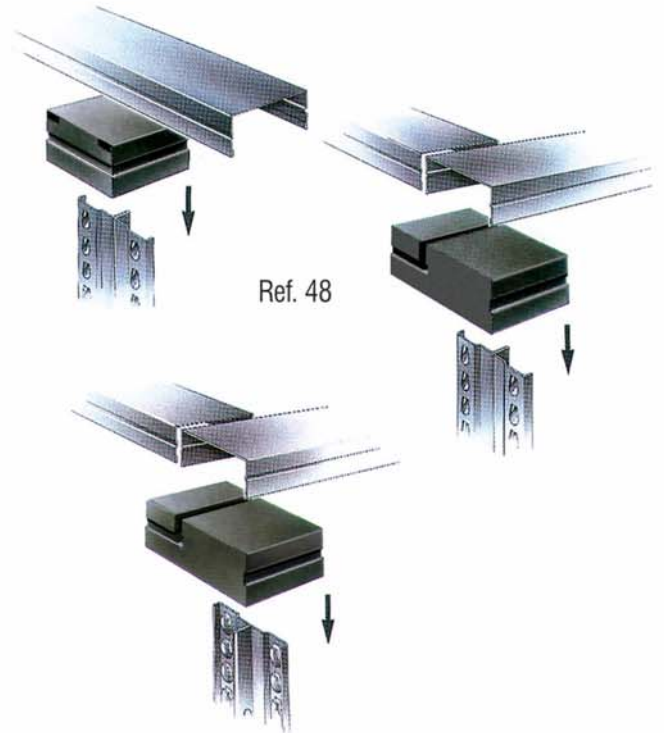
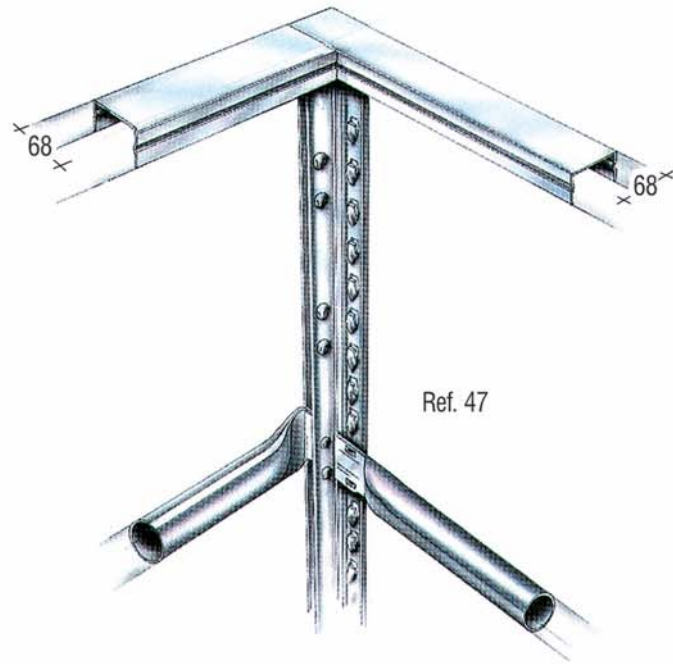

Ref. 44

inclinación 42°

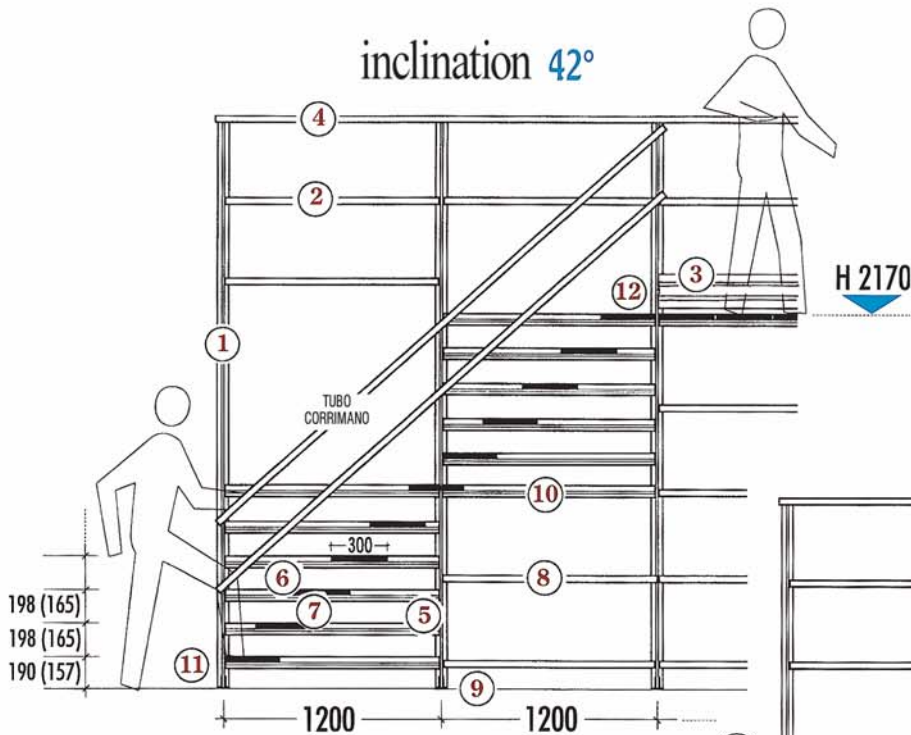

inclinación 38°

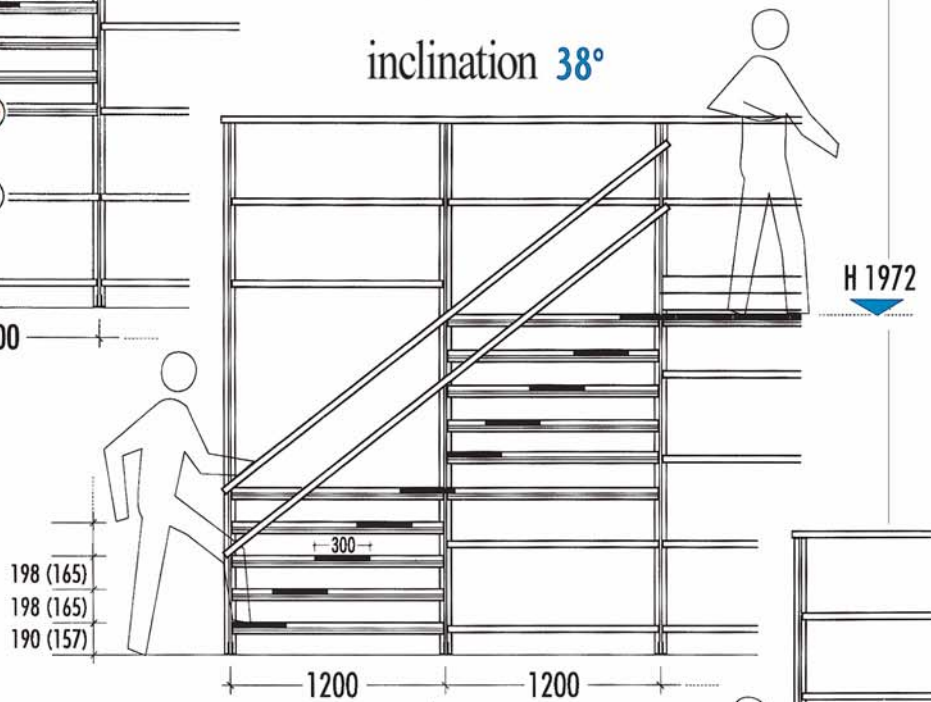

1		REINFORCED UPRIGHT	7		STAIR TREAD ANTI SLIP STEEL PLANK H58 - 15/10
2		TUBULAR BEAM	8		BEAM H47
3		SHELF BOARD	9		HEAVY DUTY STEEL BASE PLATE
4		"U"-SECTION HANDRAIL	10		T-SECTION WALKWAY SUPPORT BAR
5		BRACKET/CLIP	11		LOCKING FRAME SPACER BAR
6		SPACER BAR TO BE LOCATED UNDER EACH STAIR TREAD	12		REINFORCING BRACKET FOR UPRIGHTS

STAIRCASES

Staircases can be built using standard components and integrated into Super 3 two-tier structures. The stair treads are fixed with four clamps / screws each (art. n° 69829.95 + 00056.20).

Under each stair tread, one spacer bar has to be assembled into the "T"-section support bar H58, to improve the overall stability of the construction.

Staircases have to be adequately reinforced. It is mandatory to use reinforced uprights (art. n° 99230--95 Unirack upright profile in variable height, riveted back-to-back onto the Super 3 upright). The Super 3 uprights needs to be

equipped with the heavy duty metal base plate (art. n° 67006.95) whereas the Unirack profile is assembled with the standard metal base plate (art. n° SLACC001.95). Plastic top caps are to be located on top of the Super 3 uprights whereas the Unirack upright is already finished off with its upper top cap and will come preassembled, ready for use. Super 3 uprights are available in a 132 mm pitch in height and may be or-



Trendy Shopfitting and Display Solutions

Achieved with standard modular Super 1-2-3- shelving components. See pictures at left and at right.

Super 1-2-3 Shelving System integrated with Euroscacco Shelf Panels

The Super 1-2-3 shelving series can be integrated with Euroscacco shelf panels. This combination provides specific advantages for shopfitting applications, such as an enhanced choice among various display solutions.

Euroscacco shelf panels can be equipped and customised with a huge array of accessory items, such as wire dividers and front risers. This system is available for frames of the Super 1 series with a maximum height of 2500 mm.

Euroscacco shelves are available in smooth and perforated version, in 1000-1250-1333 mm length, to suit frame depths ranging from 300 to 700 mm, providing a load bearing capacity of 70 daN per shelf, for uniformly distributed loads. Super 1 frames, when integrated with Euroscacco shelf panels, require vertical bracing or the use of the reinforcement bar (please refer to page 41).



Reinforcement Bars

This solution couples two connection brackets with a standard 40x20 mm oval section to create a reinforced connection between two uprights of a shelving bay, substantially increasing the stiffness of the shelving row (Ref. 65). This is an ideal solution for a wide range of



Ref. 65



Ref. 65

applications where firmness is an added value, such as hanging garment shelving and retail furnishing solutions, generally characterised by low frame heights, few beam levels and short shelving row configurations.

When applying the integrated shopfitting and display solution mentioned above (Super 1-2-3 frames assembled with Euroscacco shelf panels), the bracing system may be substituted by a continuous row of reinforcement bars placed at 2/3's of the frames' height.

This configuration will provide a maximum load bearing capacity of 350 daN per bay (assuming 5 load levels at 70 daN each), with uniformly distributed loads. The design of the connection bracket creates a four pronged connection to the uprights while maintaining full access to the bay.

This unique solution not only guarantees flexibility in application but, more importantly, it ensures extraordinary nodal performance.

Reinforcement bars, like any other standard beam component, requires the mandatory application of safety pins.

For more information, please refer to METALSISTEM Informa n° 706 and to page n° 53 of this brochure.

Modular Steel Cabinets

Made from our shelving series and clad with Euroscacco steel panels, these cabinets are equipped with lockable sliding doors and are highly performing in terms of load bearing capacity. Available in zinc coated or powder coated version (Ref. 62). The standard configuration has been conceived with four modular, adjustable steel shelves made from Super 1 beams and H12 shelf panels; other configurations can be easily achieved thanks to the modular design.

Customers may use shelving components from their stock to build the framework and just order the cladding set to build the cabinet. Compared to similar products available on the market, METALSISTEM steel cabinets distinguish themselves for higher load capacities, utmost cost efficiency and solidity. Available as well in a width of 1500 mm: a feature that is not common for this product category.

For ordering, see page 53.

Mobile Ladders

Mobile ladders are available in 2000/2500/3000 mm height (in 5, 7 or 9 steps configuration) and can be supplied with guide rail and curves to adapt them to any environment (Ref. 56).

For ordering please refer to page 49.



Ref. 62



Ref. 62



Ref. 62



See more



on the web

Ref. 56

Mobile Shelving

Thanks to its attractive high-tech design, Super 1-2-3 is also a highly suitable and cost effective system to achieve mobile shelving applications. For the design and ordering of mobile shelving installations, please refer to the MOBIBASIC Technical Manual <Doc: MT16>.

Modular Sliding Doors

Sliding Doors are ideal for areas with limited corridor width and can be used to create closed spaces or cupboards. Sliding doors are supplied preassembled and are available in the standard METALSISTEM colour range. A lock is supplied as a standard accessory with every door. Sliding doors are available for 900-1200-1500 mm bay lengths, in two different heights: 2000 and 2500 mm. The sliding rails are made to match the height of the shelving beams on top and at the bottom of the shelving bay. In case of MOBIBASIC mobile shelving installations, the rails are fixed directly to the MOBIBASIC chassis and to the shelving beam on top of the bay, to ensure a dust proof connection. For more information and ordering, please refer to page 53.

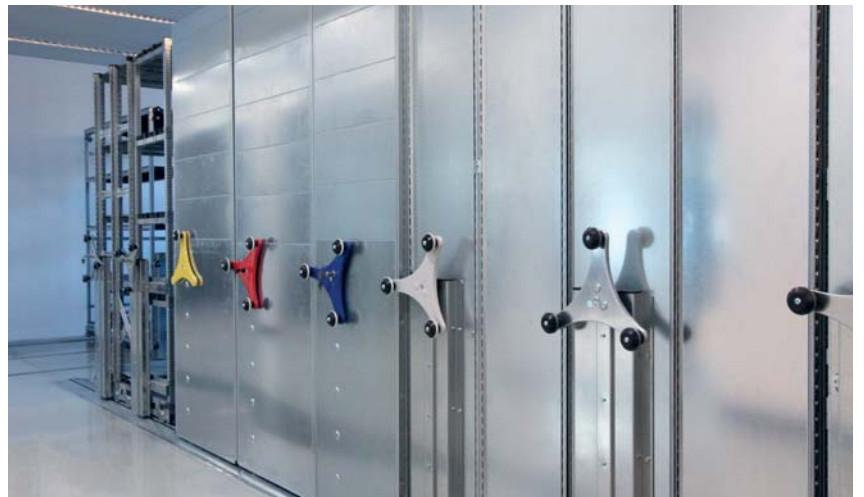

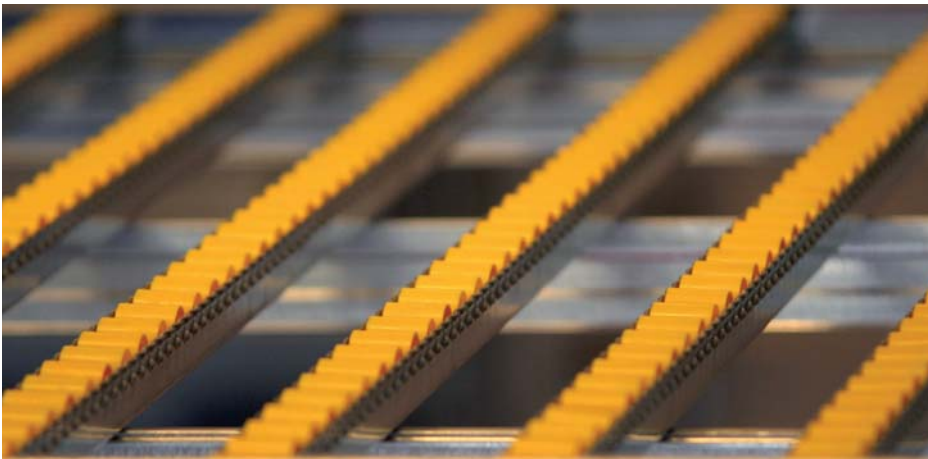

Carton Flow

Carton flow beds consist of one or more inclined runways equipped with specially designed roller tracks. Merchandise is loaded in the rear of each runway and moves toward the picking station. As an item is removed from the front, the item directly behind it slides forward in place of the previous and rolls to the front, thus allowing merchandise to remain better organized and easier to find/pick. METALSISTEM's carton flow is an economic, modular and functional solution based on standard components alone, allowing flow track beds to be created up to depths of 4 metres. The flow track profiles are made from certified, galvanised, high tensile steel and are manufactured in lengths ranging from 359 to 4022 mm at a cut pitch of 33 mm. Yellow rollers made from polypropylene are inserted into the tracks at varying pitches of either 33, 49.5, 66, 82.5 or 99 mm, according to the application requirements. The track profiles are inserted into sceenstrips that are fastened with clamps/screws (art. 69829.95/00056.20) at centre distances of approx. 1000 mm.

The support for the roller shelves is provided by frames placed at fixed intervals set by oval tubes, (the same standard components used for walkway parapet elements) thus ensuring that the beams will be aligned at a constant inclination of approximately 8% from the rear to the front side of the system. However, the most suitable degree of inclination depends on the type of packaging and weight of the load unit and the overall length of the roller track. A "T"-section support bar placed at the picking side of the run provides both support for the flow tracks and an end stop for the cartons. For more information please refer to page 54 of this brochure.

Removable Divider

The roller beds can be equipped with removable dividers that make use of the 32/4 zinc-coated profile. They are installed by pressure therefore, the width of lanes can be changed easily.

The divider can cover the entire length of the roller bed but can also be used as partial start or end roller bed division.



Steel Planking

"T"-sections can be used as support beams for the steel planking (Ref. 55). Floors of any dimension can be built in conjunction with "H" joints and "U" section channels. They are used as end and middle joints (Ref. 52-53).

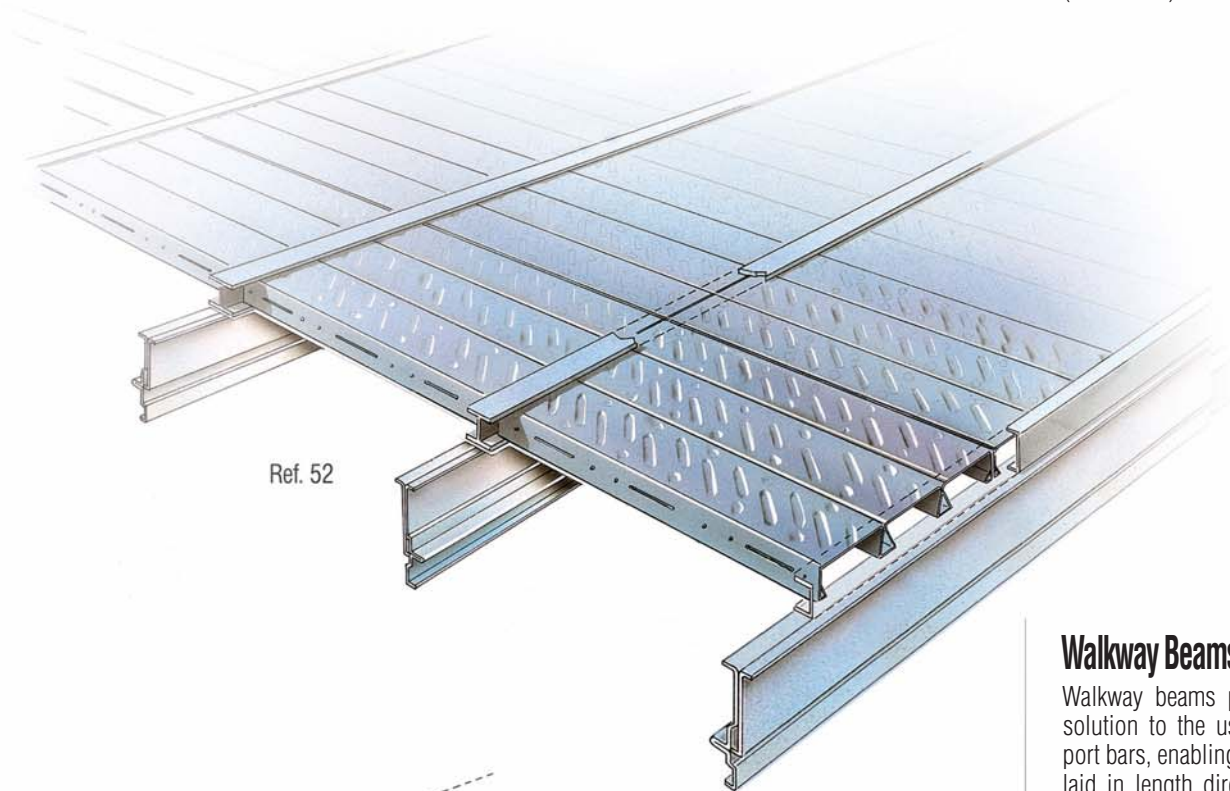

Ref. 52

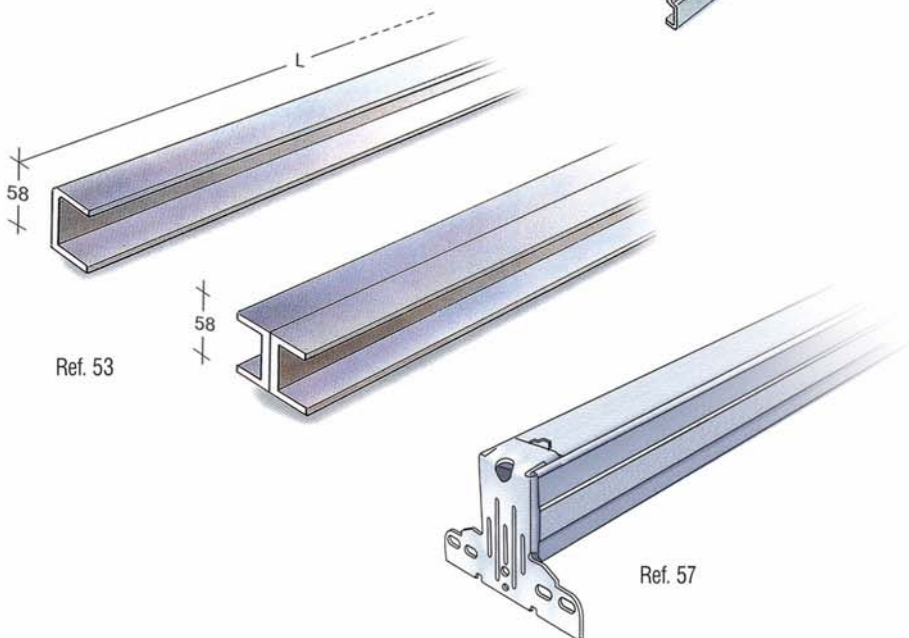

Ref. 53

Ref. 57

Walkway Beams

Walkway beams provide an alternative solution to the use of "T"-section support bars, enabling the steel planks to be laid in length direction along the walkways (Ref. 57). Walkway beams are made from a profile section 70x70/6 containing perforations along one face of the profile.

These perforations are used to connect the steel plank fixing brackets (art. 69864.98) as shown in the picture below. Thanks to their profile width of 70 mm, walkway beams provide a large and smooth surface for the connection of adjoining steel planks on top, thus ensuring appropriate continuity and evenness at the steel plank joints.

The connectors of the walkway beams are assembled directly on site and fit perfectly into the beam support brackets (art. 67022.95).

Two self-perforating screws are used to fasten the connection; see picture below. The installation of these screws is mandatory. Walkway beam profiles are ordered in nominal dimension.

Walkway Beam Assembly

Ref.	Article	Description	Q.ty
1	AI210013.95	Walkway Beam Profile 70x70/6	1
2	AI210082.95	Walkway Beam Connectors	2
3	69864.98	Steel Plank Fixing Bracket	2
4	00058.20	Screw 5,5x19	2
5	67022.95	Walkway Beam Support Bracket	2

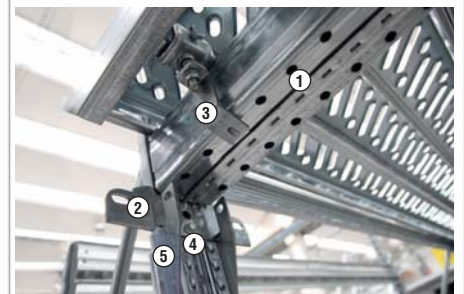

The "T"-section supports are fitted back-to-back. One is fitted on the outside of the upright by means of support brackets, and the other is fitted inside and onto the upright.

The steel planks are laid over the top and are fixed down by means of the special clamp (Ref. 54).

When joining the planks in a transverse direction the M6x20 bolt should be used in the appropriate holes.

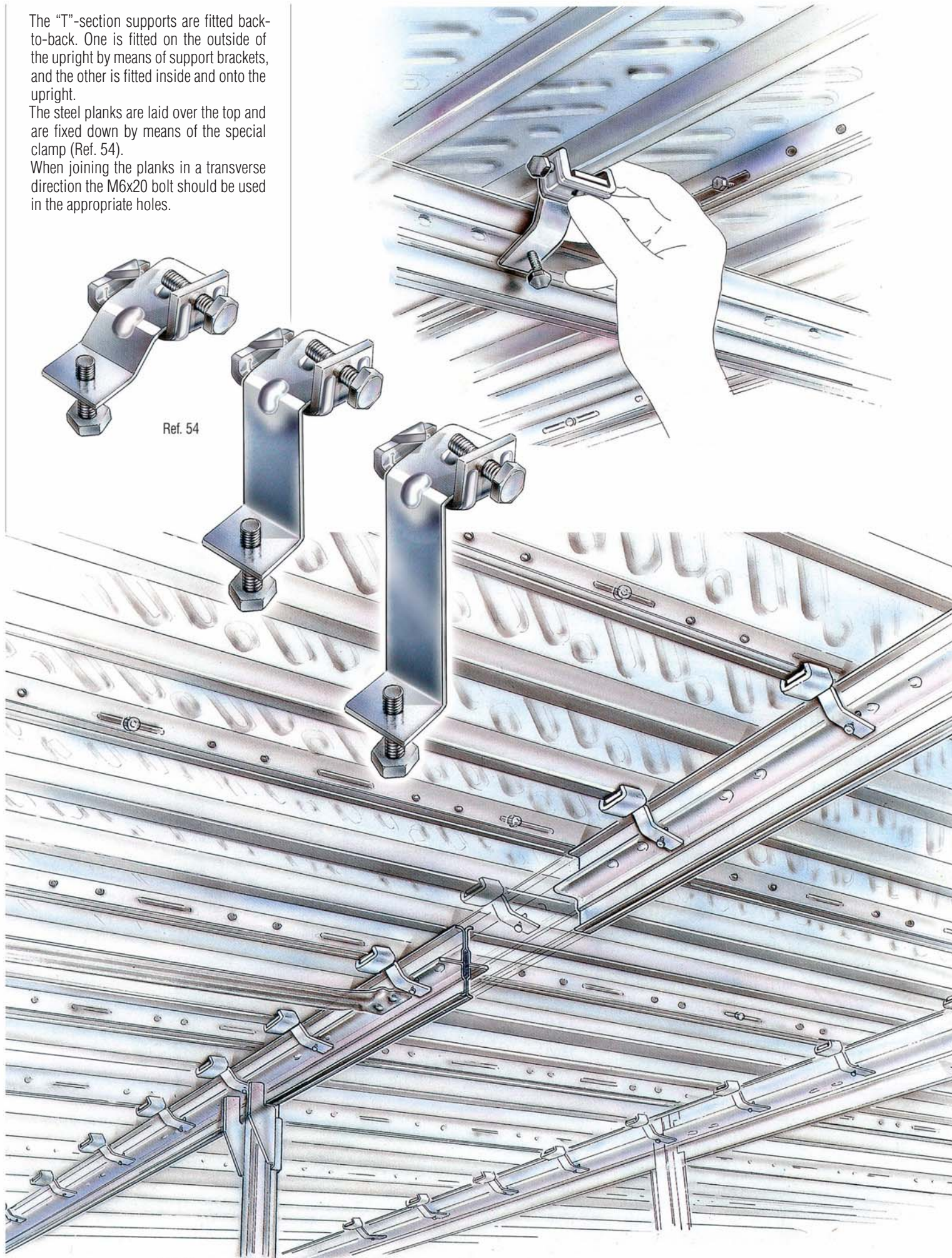

Ref. 54

Ref. 55

FRAMES COMPLETE WITH UPRIGHTS, HORIZONTAL AND DIAGONAL SPACER BARS LOAD BEARING CAPACITY daN 1100 EACH

Regarding technical data, standard specifications and assembly diagram, please refer to pages 4/5 of this brochure.

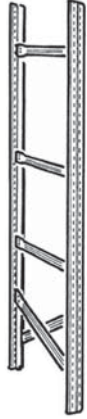

Ref. 2

component	height mm	depth mm	horizontal and diagonal spacer bars
70100.95	1576	320	4
70103.95	1840	320	4
70106.95	1972	320	5
70109.95	1576	400	4
70112.95	1840	400	4
70115.95	1972	400	5
70118.95	1576	500	4
70121.95	1840	500	4
70124.95	1972	500	5
70127.95	1576	600	4
70130.95	1840	600	4
70133.95	1972	600	5
70136.95	1576	700	4
70139.95	1840	700	4
70142.95	1972	700	5
70145.95	1576	800	4
70148.95	1840	800	4
70151.95	1972	800	5

UPRIGHT SUPER-ZERO

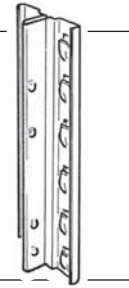

Ref. 2

component	height mm
10510.95	1576
10520.95	1840
10530.95	1972

Super-ZERO uprights and frames are to be used with Super-ZERO beams and shelves, only.

Consequently, the max. bay length for shelving made with the Super-ZERO series is 900 / 1050 / 1200 mm only, with a max. load capacity of 200 daN/shelf, uniformly distributed loads.

BEAM SUPER-ZERO



Ref. 3

component	length mm	Load <daN> per pair uniformly distrib. load
30000L.95	600	200
30001L.95	900	200
30003L.95	1050	170
30004L.95	1200	150

The load bearing capacity of the beams is to be understood as referring to uniformly distributed loads, per pair of beams. The load bearing indication is valid and applicable for a use of the beams with modular shelves and/or modular containers only.

SHOPFITTING ACCESSORIES

component	depth mm
-----------	----------

Chrome-plated hooks, bars and wire rods



031.006.21	350
031.005.21	400



031.028.21	350
031.031.21	400
031.030.21	500

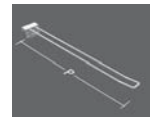

031.025.21	350
------------	-----

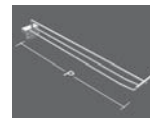

031.086.21	200
031.080.21	400



207.004.21	350
207.006.21	450

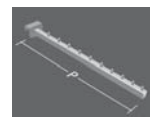

207.014.21	350
207.016.21	450

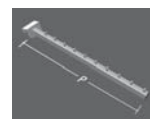

207.024.21	350
207.026.21	450

COMPLETE SHELVES WITH BEAMS SUPER-ZERO AND PANELS H12 mm

Regarding technical data and standard specifications, please refer to pages 4/5 of this brochure.

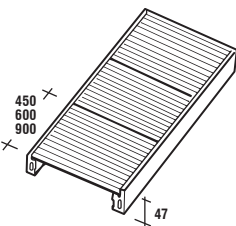

Ref. 5

component	length mm	depth mm	Load capacity <daN> uniformly distrib. load
80001.95	900	320	200
80004.95	900	400	200
80007.95	900	500	185
80010.95	900	600	150
80013.95	900	700	130
80014.95	1050	320	170
80015.95	1050	400	170
80016.95	1050	500	170
80017.95	1050	600	170
80018.95	1050	700	155
80019.95	1200	320	150
80022.95	1200	400	150
80025.95	1200	500	150
80028.95	1200	600	150
80031.95	1200	700	150

COMPLETE SHELVES WITH BEAMS SUPER-ZERO AND PANELS H25/A

Regarding technical data and standard specifications, please refer to pages 4/5 of this brochure.

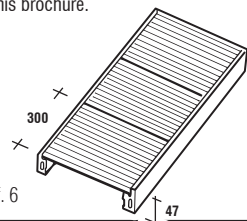

Ref. 6

component	length mm	depth mm	Load capacity <daN> uniformly distrib. load
80004A.95	900	400	200
80007A.95	900	500	200
80010A.95	900	600	200
80013A.95	900	700	200
80016A.95	900	800	200
80022A.95	1200	400	150
80025A.95	1200	500	150
80028A.95	1200	600	150
80031A.95	1200	700	150
80034A.95	1200	800	150

**FRAMES COMPLETE WITH UPRIGHTS, HORIZONTAL AND DIAGONAL SPACER BARS
LOAD BEARING CAPACITY
daN 1500 EACH**

Regarding technical data, standard specifications and assembly diagram, please refer to pages 4/5 of this brochure.

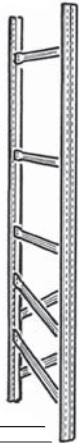

Ref. 2

component	height mm	depth mm	horizontal & diagonal spacer bars
70001.95	1972	320	5
70004.95	2500	320	6
70007.95	3028	320	8
70010.95	1972	400	5
70013.95	2500	400	6
70016.95	3028	400	8
70019.95	1972	500	5
70022.95	2500	500	6
70025.95	3028	500	8
70028.95	1972	600	5
70031.95	2500	600	6
70034.95	3028	600	8
70037.95	1972	700	5
70040.95	2500	700	6
70043.95	3028	700	8
70046.95	1972	800	5
70049.95	2500	800	6
70052.95	3028	800	8

UPRIGHT S1



Ref. 2

component	height mm
10001.95	1972
10004.95	2500
10007.95	3028

BEAM S1



Ref. 3

component	length mm	Load <daN> per pair - u.d.l.
30000.95	600	280
30001.95	900	280
30003.95	1050	235
30004.95	1200	205
30005.95	1350	180
30007.95	1500	145
30008.95	1650	120

The load bearing capacity of the beams is to be understood as referring to uniformly distributed loads, per pair of beams. The load bearing indication is valid and applicable for a use of the beams with modular shelves and/or modular containers only.

COMPLETE SHELVES WITH BEAMS S1 AND PANELS H12 mm

Regarding technical data and standard specifications, please refer to pages 4/5 of this brochure.

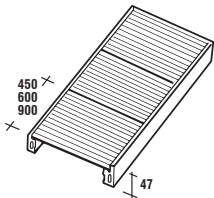

Ref. 5

component	length mm	depth mm	Load capacity <daN> u.d.l.
80501.95	900	320	280
80504.95	900	400	235
80507.95	900	500	185
80510.95	900	600	150
80513.95	900	700	130
80519.95	1200	320	205
80522.95	1200	400	205
80525.95	1200	500	205
80528.95	1200	600	205
80531.95	1200	700	180
80537.95	1500	320	145
80540.95	1500	400	145
80543.95	1500	500	145
80546.95	1500	600	145
80549.95	1500	700	145

COMPLETE SHELVES WITH BEAMS S1 AND PANELS H25/A

Regarding technical data and standard specifications, please refer to pages 4/5 of this brochure.

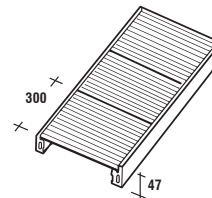

Ref. 6

component	length mm	depth mm	Load capacity <daN> u.d.l.
80504A.95	900	400	280
80507A.95	900	500	280
80510A.95	900	600	280
80513A.95	900	700	280
80516A.95	900	800	230
80522A.95	1200	400	205
80525A.95	1200	500	205
80528A.95	1200	600	205
80531A.95	1200	700	205
80534A.95	1200	800	180
80540A.95	1500	400	145
80543A.95	1500	500	145
80546A.95	1500	600	145
80549A.95	1500	700	145
80552A.95	1500	800	130

EUROSCACCO SHELF PANEL powder coated, white

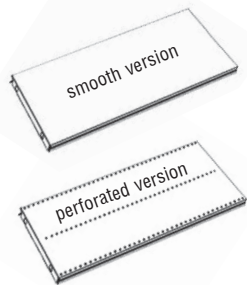

Pag. 34

length mm	depth mm	article code n° smooth shelf	article code n° perforated shelf
1000	300	636.002.01	626.002.01
1000	400	636.012.01	626.012.01
1000	500	636.022.01	626.022.01
1000	600	636.032.01	626.032.01
1000	700	636.042.01	626.042.01
1250	300	636.007.01	626.007.01
1250	400	636.017.01	626.017.01
1250	500	636.027.01	626.027.01
1250	600	636.037.01	626.037.01
1250	700	636.047.01	626.047.01
1330	300	636.004.01	626.004.01
1330	400	636.014.01	626.014.01
1330	500	636.024.01	626.024.01
1330	600	636.034.01	626.034.01
1330	700	636.044.01	626.044.01

BRACING KIT

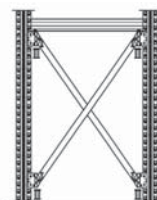

Pag. 34

for nominal bay lengths	L=1000 mm	L=1250 mm	L=1330 mm
macro-code	67027.98	67028.98	67029.98
composed of			
68051.95	n° 4	n° 4	n° 4
00020.20	n° 12	n° 12	n° 12
00027.20	n° 8	n° 8	n° 8
00035.20	n° 4	n° 4	n° 4
bracing diagonal	2x 68046/S.95	2x 68047/S.95	2x 68048/S.95
length of diagonal	1332 mm	1511 mm	1572 mm

FRAME SPACER BAR FOR EUROSCACCO SHELF PANELS



Pag. 34

component	depth mm
41701.95	300
41704.95	400
41707.95	500
41710.95	600
41713.95	700

TECHNICAL NOTES: Suitable for Super-1 frames with a maximum height of 2500 mm. Each shelving row needs at least one vertical bracing kit each 5 bays. The load bearing capacity per shelf is 70daN for uniformly distributed loads. Each shelving bay has to be built with at least 3 shelf levels in height. The ratio between depth and height should be max. 1:5, alternatively the structure needs to be fastened to the wall. When applying the integrated shopfitting and display solution mentioned above (Super 1-2-3 frames assembled with Euroscacco shelf panels), the bracing system may be substituted by a continuous row of reinforcement bars placed at 2/3's of the frames' height. This configuration will provide a maximum load bearing capacity of 350 daN per bay (assuming 5 load levels at 70 daN each), with uniformly distributed loads.

FRAMES COMPLETE WITH UPRIGHTS, HORIZONTAL AND DIAGONAL BRACING LOAD BEARING CAPACITY Kg. 2000 EACH

Regarding technical data, standard specifications and assembly diagram, please refer to pages 4/5 of this brochure.

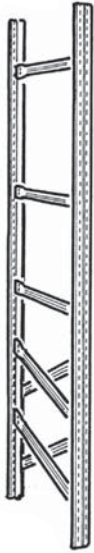

Ref. 2

component	height mm	depth mm	horizontal and diagonal spacer bars
71001.95	1972	320	5
71004.95	2500	320	6
71007.95	3028	320	8
71010.95	3424	320	10
71016.95	1972	400	5
71019.95	2500	400	6
71022.95	3028	400	8
71025.95	3424	400	10
71031.95	1972	500	5
71034.95	2500	500	6
71037.95	3028	500	8
71040.95	3424	500	10
71046.95	1972	600	5
71049.95	2500	600	6
71052.95	3028	600	8
71055.95	3424	600	10
71061.95	1972	700	5
71064.95	2500	700	6
71067.95	3028	700	8
71070.95	3424	700	10
71076.95	1972	800	5
71079.95	2500	800	6
71082.95	3028	800	8
71085.95	3424	800	10

UPRIGHT S2



Ref. 2

component	height mm
11001.95	1972
11004.95	2500
11007.95	3028
11010.95	3424

BEAM S2



component	length mm	Load <daN> per pair uniformly distrib. load
31501.95	900	390
31503.95	1050	335
31504.95	1200	275
31505.95	1350	220
31507.95	1500	175
31508.95	1650	145

The load bearing capacity of the beams is to be understood as referring to uniformly distributed loads, per pair of beams. The load bearing indication is valid and applicable for a use of the beams with modular shelves H12/H25 and/or modular containers only.

COMPLETE SHELVES WITH BEAMS S2 AND PANELS H12

Regarding technical data and standard specifications, please refer to pages 4/5 of this brochure.

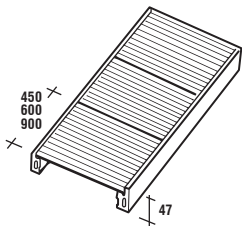

Ref. 5

component	length mm	depth mm	Load capacity <daN> uniformly distrib. load
81001.95	900	320	305
81004.95	900	400	235
81007.95	900	500	185
81010.95	900	600	150
81013.95	900	700	130
81019.95	1200	320	275
81022.95	1200	400	275
81025.95	1200	500	260
81028.95	1200	600	210
81031.95	1200	700	180
81037.95	1500	320	175
81040.95	1500	400	175
81043.95	1500	500	175
81046.95	1500	600	175
81049.95	1500	700	175

HORIZONTAL SPACER BAR

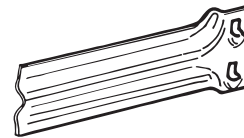

Ref. 2

component	depth mm
41001.95	320
41004.95	400
41007.95	500
41010.95	600
41013.95	700
41016.95	800

DIAGONAL SPACER BAR

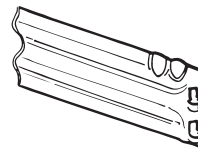

Ref. 2

component	depth mm
43001.95	320
43004.95	400
43007.95	500
43010.95	600
43013.95	700
43016.95	800

COMPLETE SHELVES WITH BEAMS S2 AND PANELS H25/A

Regarding technical data and standard specifications, please refer to pages 4/5 of this brochure.

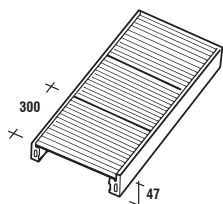

Ref. 6

component	length mm	depth mm	Load capacity <daN> uniformly distrib. load
81504A.95	900	400	390
81507A.95	900	500	390
81510A.95	900	600	345
81513A.95	900	700	285
81516A.95	900	800	230
81522A.95	1200	400	275
81525A.95	1200	500	275
81528A.95	1200	600	275
81531A.95	1200	700	275
81534A.95	1200	800	250
81540A.95	1500	400	175
81543A.95	1500	500	175
81546A.95	1500	600	175
81549A.95	1500	700	175
81552A.95	1500	800	160

LOCKING FRAME SPACER BAR



Ref. 1B

component	depth mm
67031.95	320
67032.95	400
67033.95	500
67034.95	600
67035.95	700
67036.95	800

**FRAMES COMPLETE WITH UPRIGHTS, HORIZONTAL AND DIAGONAL BRACING
LOAD BEARING CAPACITY
Kg. 3600 EACH**

Regarding technical data, standard specifications and assembly diagram, please refer to pages 4/5 of this brochure.

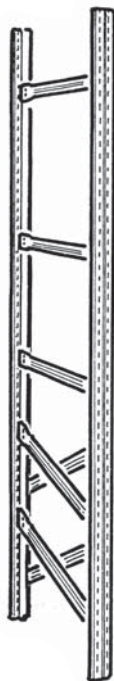

Ref. 2

component	height mm	depth mm	horizontal and diagonal spacer bars
72001.95	1972	320	5
72004.95	2500	320	6
72007.95	3028	320	8
72010.95	3424	320	10
72013.95	3952	320	11
72016.95	4480	320	13
72019.95	5008	320	15
72022.95	1972	400	5
72025.95	2500	400	6
72028.95	3028	400	8
72031.95	3424	400	10
72034.95	3952	400	11
72037.95	4480	400	13
72040.95	5008	400	15
72043.95	1972	500	5
72046.95	2500	500	6
72049.95	3028	500	8
72052.95	3424	500	10
72055.95	3952	500	11
72058.95	4480	500	13
72061.95	5008	500	15
72064.95	1972	600	5
72067.95	2500	600	6
72070.95	3028	600	8
72073.95	3424	600	10
72076.95	3952	600	11
72079.95	4480	600	13
72082.95	5008	600	15
72085.95	1972	700	5
72088.95	2500	700	6
72091.95	3028	700	8
72094.95	3424	700	10
72097.95	3952	700	11
72100.95	4480	700	13
72103.95	5008	700	15
72106.95	1972	800	5
72109.95	2500	800	6
72112.95	3028	800	8
72115.95	3424	800	10
72118.95	3952	800	11
72121.95	4480	800	13
72124.95	5008	800	15

UPRIGHT S3



Ref. 2

component	height mm
12001.95	1972
12004.95	2500
12007.95	3028
12010.95	3424
12013.95	3952
12016.95	4480
12019.95	5008

BEAM S3



Ref. 3

component	length mm	Load <daN> per pair - u.d.l.
32501.95	900	450
32503.95	1050	385
32504.95	1200	320
32505.95	1350	255
32507.95	1500	205
32508.95	1650	170
32510.95	1800	140

The load bearing capacity of the beams is to be understood as referring to uniformly distributed loads, per pair of beams. The load bearing indication is valid and applicable for a use of the beams with modular shelves and/or modular containers only.

COMPLETE SHELVES WITH BEAMS S3 AND PANELS H12

Regarding technical data and standard specifications, please refer to pages 4/5 of this brochure.

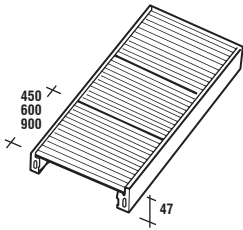

Ref. 5

component	length mm	depth mm	Load capacity <daN> uniformly distrib. load
82001.95	900	320	305
82004.95	900	400	235
82007.95	900	500	185
82010.95	900	600	150
82013.95	900	700	130
82019.95	1200	320	320
82022.95	1200	400	320
82025.95	1200	500	260
82028.95	1200	600	210
82031.95	1200	700	180
82037.95	1500	320	205
82040.95	1500	400	205
82043.95	1500	500	205
82046.95	1500	600	205
82049.95	1500	700	205
82055.95	1800	320	140
82058.95	1800	400	140
82061.95	1800	500	140
82064.95	1800	600	140
82067.95	1800	700	140

COMPLETE SHELVES WITH BEAMS S3 AND PANELS H25/A

Regarding technical data and standard specifications, please refer to pages 4/5 of this brochure.

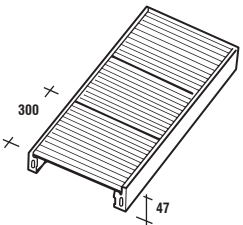

Ref. 6

component	length mm	depth mm	Load capacity <daN> uniformly distrib. load
82504A.95	900	400	450
82507A.95	900	500	420
82510A.95	900	600	345
82513A.95	900	700	285
82516A.95	900	800	230
82522A.95	1200	400	320
82525A.95	1200	500	320
82528A.95	1200	600	320
82531A.95	1200	700	320
82534A.95	1200	800	290
82540A.95	1500	400	205
82543A.95	1500	500	205
82546A.95	1500	600	205
82549A.95	1500	700	205
82552A.95	1500	800	180
82564A.95	1800	400	140
82567A.95	1800	500	140
82570A.95	1800	600	140
82573A.95	1800	700	140

PERFORATED SHELF PANEL

300 mm wide - H25 - with flanged ends hole diameter 6.5 mm perforation 50% of the shelf surface

Regarding technical data and standard specifications, please refer to pages 4/5 of this brochure and to METALSISTEM Informa n° 577.

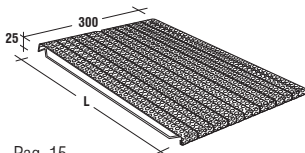

Pag. 15

article H25/C	load capacity <daN> uniformly distrib. load	depth mm	article H25/D	load capacity <daN> uniformly distrib. load
52521.95	150	400	52541.95	180
52524.95	150	500	52544.95	180
52527.95	120	600	52547.95	150
52530.95	95	700	52550.95	120
52533.95	70	800	52553.95	85

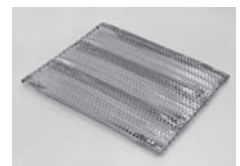

The load bearing capacities indicated in this table refer to uniformly distributed loads <daN> per shelf panel.

The load bearing capacity of a complete shelf will be given by the smallest value between the load bearing capacity per pair of beams against the sum of load bearing capacities of the number of shelf panels in the bay. If the load capacity per pair of beams is lower compared to the sum of shelf panels, then the lower data will apply.

We recommend care when using containers with steel runners or steel foot plates or other items introducing point loads: due to the perforated shelf surface, the shelf panels are not suited to accept point loads. See also METALSISTEM Informa n° 577.

BEAM S1G

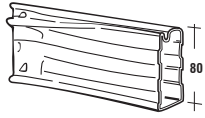

Ref. 6 bis

component	length mm	Load <daN> per pair uniformly distrib. load
-----------	-----------	---

32604.95	1500	350
32607.95	1800	310

The load bearing capacity of the beams is to be understood as referring to uniformly distributed loads, per pair of beams. The load bearing indication is valid and applicable for a use of the beams with modular shelves and/or modular containers only.

COMPLETE SHELVES WITH BEAMS S1G AND PANELS H12

Regarding technical data and standard specifications, please refer to pages 4/5 of this brochure.

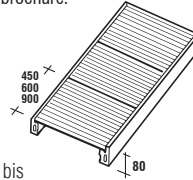

Ref. 6 bis

component	length mm	depth mm	Load capacity <daN> u.d.l.
-----------	-----------	----------	----------------------------

83116.95	1500	320	350
83119.95	1500	400	350
83122.95	1500	500	315
83125.95	1500	600	260
83128.95	1500	700	220

83131.95	1800	320	310
83134.95	1800	400	310
83137.95	1800	500	310
83140.95	1800	600	305
83143.95	1800	700	260

BEAM S2G

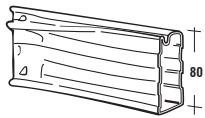

Ref. 6 bis

component	length mm	Load <daN> per pair uniformly distrib. load
-----------	-----------	---

34004.95	1500	520
34007.95	1800	430

The load bearing capacity of the beams is to be understood as referring to uniformly distributed loads, per pair of beams. The load bearing indication is valid and applicable for a use of the beams with modular shelves and/or modular containers only.

COMPLETE SHELVES WITH BEAMS S1G AND PANELS H25/A

Regarding technical data and standard specifications, please refer to pages 4/5 of this brochure.

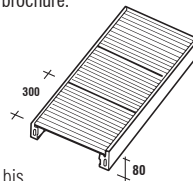

Ref. 6 bis

component	length mm	depth mm	Load capacity <daN> u.d.l.
-----------	-----------	----------	----------------------------

83340A.95	1500	400	350
83343A.95	1500	500	350
83346A.95	1500	600	350
83349A.95	1500	700	350
83352A.95	1500	800	350

83364A.95	1800	400	310
83367A.95	1800	500	310
83370A.95	1800	600	310
83373A.95	1800	700	310

BEAM S3G

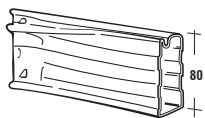

Ref. 6 bis

component	length mm	Load <daN> per pair uniformly distrib. load
-----------	-----------	---

35004.95	1500	640
35007.95	1800	530

The load bearing capacity of the beams is to be understood as referring to uniformly distributed loads, per pair of beams. The load bearing indication is valid and applicable for a use of the beams with modular shelves and/or modular containers only.

COMPLETE SHELVES WITH BEAMS S2G AND PANELS H25/A

Regarding technical data and standard specifications, please refer to pages 4/5 of this brochure.

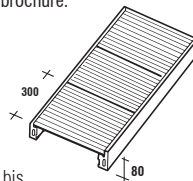

Ref. 6 bis

component	length mm	depth mm	Load capacity <daN> u.d.l.
-----------	-----------	----------	----------------------------

83540A.95	1500	400	520
83543A.95	1500	500	520
83546A.95	1500	600	520
83549A.95	1500	700	520
83552A.95	1500	800	425

83564A.95	1800	400	430
83567A.95	1800	500	430
83570A.95	1800	600	430
83573A.95	1800	700	430

COMPLETE SHELVES WITH BEAMS S3G AND PANELS H25/A

Regarding technical data and standard specifications, please refer to pages 4/5 of this brochure.

Ref. 6 bis

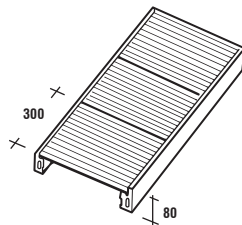

COMPLETE SHELVES WITH BEAMS S3G AND PANELS H25/B

Regarding technical data and standard specifications, please refer to pages 4/5 of this brochure.

Ref. 6 bis

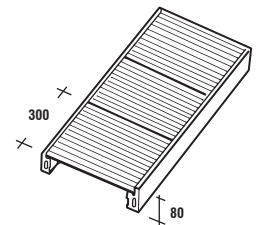

component	length mm	depth mm	Load capacity <daN> uniformly distrib. load
-----------	-----------	----------	---

84540A.95	1500	400	640
84543A.95	1500	500	640
84546A.95	1500	600	640
84549A.95	1500	700	475
84552A.95	1500	800	425

84564A.95	1800	400	530
84567A.95	1800	500	530
84570A.95	1800	600	530
84573A.95	1800	700	530

component	length mm	depth mm	Load capacity <daN> uniformly distrib. load
-----------	-----------	----------	---

84540B.95	1500	400	640
84543B.95	1500	500	640
84546B.95	1500	600	640
84549B.95	1500	700	550
84552B.95	1500	800	475

84564B.95	1800	400	530
84567B.95	1800	500	530
84570B.95	1800	600	530
84573B.95	1800	700	530









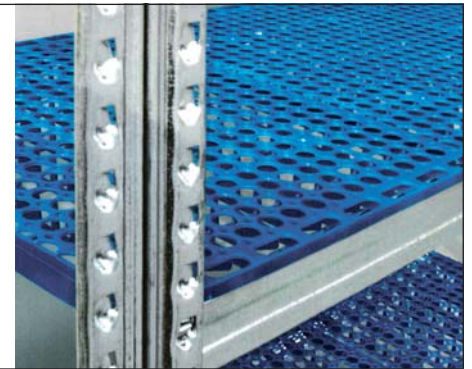





































































































METALSISTEM's plastic shelf panels are made from high quality polypropylene according to the RoHS directive and compatible for use within the food sector. The perforation is >50% of the shelf surface area. FROST shelf panels are available for use in cooling rooms. FROST shelf panels are made from specific materials and additives to achieve a higher grade of suppleness. Their use is restricted to environments below 0° C. Load bearing capacities are indicated below and refer to uniformly distributed loads, differentiated according to the degree of deflection. See also page 15, Ref. 60.

Additionally to the plastic shelf panels in 300 mm width, compensation panels in 150 mm and 200 mm width are also available to suit bay lengths of 1050/1350/1650 mm.

The load bearing capacities of these compensation panels are indicated below and refer to uniformly distributed loads, differentiated according to the degree of deflection.







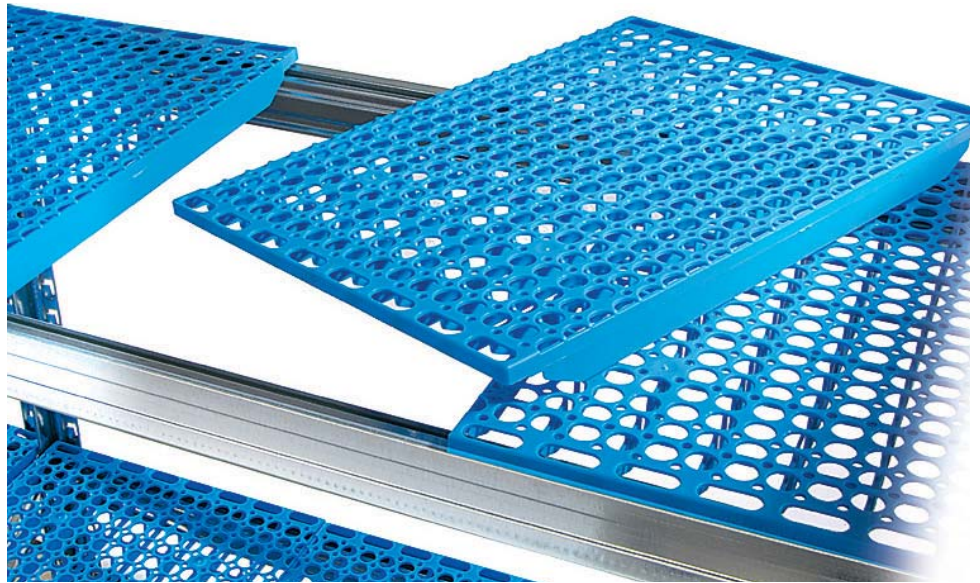



























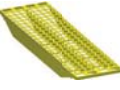









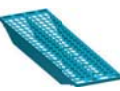



















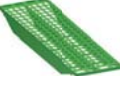









Notes: High temperature increase the shelves' suppleness while low temperatures make them brittle. The material used for the manufacture of standard plastic shelves is optimised to offer best performance at room temperature. Frost shelf panels contain an additive allowing the shelves to be applied in cooling rooms, at low temperatures. The use of our shelf panels in environments other than those indicated could compromise performance.



Article Code	 Low deflection  High deflection		Type of Shelf	Colour	Nominal Depth (mm)	Impact resistance	Field of application (°C)		
	Panel width	Load bearing capacity (daN) - u.d.l.					-30°- 0°	0°- +7°	+7°- +30°
L=300 mm	L=300 mm	L=300 mm							
PL30X32D1.98	40	-	FROST	Frost Green	320		 GOOD	 NOT SO GOOD	 NOT GOOD
PL30X40D1.98	40	-			400		 GOOD	 NOT SO GOOD	 NOT GOOD
PL30X50D1.98	40	-			500		 GOOD	 NOT SO GOOD	 NOT GOOD
PL30X32C1.98	35	45	STANDARD	White	320		 NOT GOOD	 NOT SO GOOD	 GOOD
PL30X40C1.98	35	45			400		 NOT GOOD	 NOT SO GOOD	 GOOD
PL30X50C1.98	25	45			500		 NOT GOOD	 NOT SO GOOD	 GOOD
PL30X60C1.98	15	30			600		 NOT GOOD	 NOT GOOD	 GOOD
PL30X32A1.98	35	45	STANDARD	Yellow	320		 NOT GOOD	 NOT SO GOOD	 GOOD
PL30X40A1.98	35	45			400		 NOT GOOD	 NOT SO GOOD	 GOOD
PL30X50A1.98	25	45			500		 NOT GOOD	 NOT SO GOOD	 GOOD
PL30X60A1.98	15	30			600		 NOT GOOD	 NOT GOOD	 GOOD
PL30X32B1.98	35	45	STANDARD	Light Blue	320		 NOT GOOD	 NOT SO GOOD	 GOOD
PL30X40B1.98	35	45			400		 NOT GOOD	 NOT SO GOOD	 GOOD
PL30X50B1.98	25	45			500		 NOT GOOD	 NOT SO GOOD	 GOOD
PL30X60B1.98	15	30			600		 NOT GOOD	 NOT GOOD	 GOOD
PL30X32B2.98	35	45	STANDARD	Blue	320		 NOT GOOD	 NOT SO GOOD	 GOOD
PL30X40B2.98	35	45			400		 NOT GOOD	 NOT SO GOOD	 GOOD
PL30X50B2.98	25	45			500		 NOT GOOD	 NOT SO GOOD	 GOOD
PL30X60B2.98	15	30			600		 NOT GOOD	 NOT GOOD	 GOOD
PL30X32V1.98	35	45	STANDARD	Dark Green	320		 NOT GOOD	 NOT SO GOOD	 GOOD
PL30X40V1.98	35	45			400		 NOT GOOD	 NOT SO GOOD	 GOOD
PL30X50V1.98	25	45			500		 NOT GOOD	 NOT SO GOOD	 GOOD
PL30X60V1.98	15	30			600		 NOT GOOD	 NOT GOOD	 GOOD
PL30X32N1.98	35	45	STANDARD	Black	320		 NOT GOOD	 NOT SO GOOD	 GOOD
PL30X40N1.98	35	45			400		 NOT GOOD	 NOT SO GOOD	 GOOD
PL30X50N1.98	25	45			500		 NOT GOOD	 NOT SO GOOD	 GOOD
PL30X60N1.98	15	30			600		 NOT GOOD	 NOT GOOD	 GOOD



Additionally to the plastic shelf panels in 300 mm width, compensation panels in 150 mm and 200 mm width are also available to suit bay lengths of 1050/1350/1650 mm. The load bearing capacities of these compensation panels are indicated below and refer to uniformly distributed loads, differentiated according to the degree of deflection.

Article Code	 Low deflection		 High deflection		Type of Shelf	Colour	Depth (mm)	Impact resistance	Field of application (°C)			Article Code	 Low deflection		 High deflection	
	Panel width	Load bearing capacity (daN) - u.d.l.		Panel width					Load bearing capacity (daN) - u.d.l.		-30° - 0°		0° - +7°	+7° - +30°	Panel width	Load bearing capacity (daN) - u.d.l.
L=200 mm	L=200 mm	L=200 mm							L=150 mm	L=150 mm	L=150 mm					
PL20X32D1.98	27	-	FROST			Frost Green		320				PL15X32D1.98	20	-		
PL20X40D1.98	27	-						400				PL15X40D1.98	20	-		
PL20X50D1.98	27	-						500				PL15X50D1.98	20	-		
PL20X32C1.98	23	30	STANDARD			White		320				PL15X32C1.98	18	23		
PL20X40C1.98	23	30						400				PL15X40C1.98	18	23		
PL20X50C1.98	17	30						500				PL15X50C1.98	13	23		
PL20X32A1.98	23	30				Yellow		320				PL15X32A1.98	18	23		
PL20X40A1.98	23	30						400				PL15X40A1.98	18	23		
PL20X50A1.98	17	30						500				PL15X50A1.98	13	23		
PL20X32B1.98	23	30				Light Blue		320				PL15X32B1.98	18	23		
PL20X40B1.98	23	30						400				PL15X40B1.98	18	23		
PL20X50B1.98	17	30						500				PL15X50B1.98	13	23		
PL20X32B2.98	23	30				Blue		320				PL15X32B2.98	18	23		
PL20X40B2.98	23	30						400				PL15X40B2.98	18	23		
PL20X50B2.98	17	30						500				PL15X50B2.98	13	23		
PL20X32V1.98	23	30				Dark Green		320				PL15X32V1.98	18	23		
PL20X40V1.98	23	30						400				PL15X40V1.98	18	23		
PL20X50V1.98	17	30						500				PL15X50V1.98	13	23		
PL20X32N1.98	23	30	Black		320				PL15X32N1.98	18	23					
PL20X40N1.98	23	30			400				PL15X40N1.98	18	23					
PL20X50N1.98	17	30			500				PL15X50N1.98	13	23					

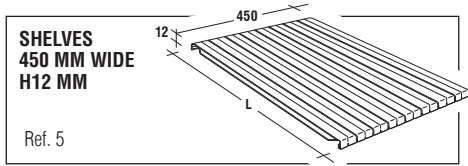

**SHELVES
450 MM WIDE
H12 MM**

Ref. 5

component	depth mm
51701.95	320
51704.95	400
51707.95	500
51710.95	600
51713.95	700

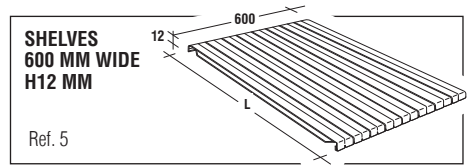

**SHELVES
600 MM WIDE
H12 MM**

Ref. 5

component	depth mm
51101.95	320
51104.95	400
51107.95	500
51110.95	600
51113.95	700

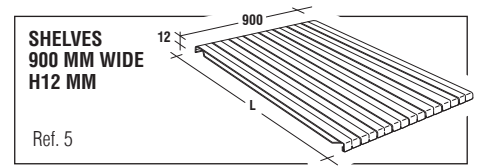

**SHELVES
900 MM WIDE
H12 MM**

Ref. 5

component	depth mm
51601.95	320
51604.95	400
51607.95	500
51610.95	600
51613.95	700

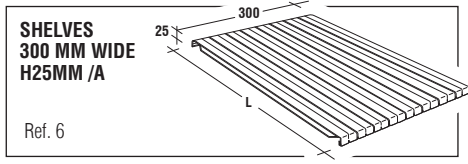

**SHELVES
300 MM WIDE
H25MM /A**

Ref. 6

component	depth mm
52301.95	400
52304.95	500
52307.95	600
52310.95	700
52313.95	800

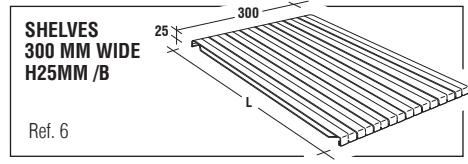

**SHELVES
300 MM WIDE
H25MM /B**

Ref. 6

component	depth mm
52401.95	400
52404.95	500
52407.95	600
52410.95	700
52413.95	800

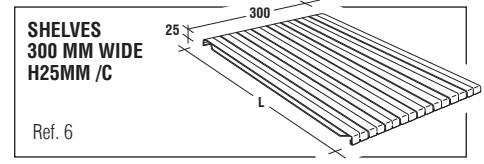

**SHELVES
300 MM WIDE
H25MM /C**

Ref. 6

component	depth mm
52501.95	400
52504.95	500
52507.95	600
52510.95	700
52513.95	800

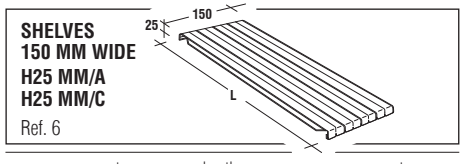

**SHELVES
150 MM WIDE
H25 MM/A
H25 MM/C**

Ref. 6

component H25/A	depth mm	component H25/C
52271.95	400	52471.95
52274.95	500	52474.95
52277.95	600	52477.95
52280.95	700	52480.95
52283.95	800	52483.95

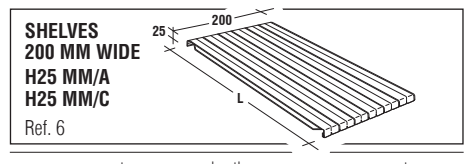

**SHELVES
200 MM WIDE
H25 MM/A
H25 MM/C**

Ref. 6

component H25/A	depth mm	component H25/C
52290.95	400	52490.95
52292.95	500	52492.95
52294.95	600	52494.95
52296.95	700	52496.95
52298.95	800	52498.95

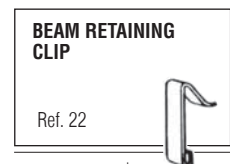

Ref. 22

component
67016.95



Ref. 25

component
67017.98



**FASTENING CLIP
FOR SHELF PANELS**
Ref. 66

component
AL210005.95

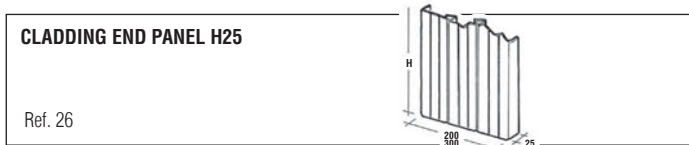

CLADDING END PANEL H25

Ref. 26

component	height x depth mm	component	height x depth mm
62001.95	1485x200	62501.95	1485x300
62004.95	1940x200	62504.95	1940x300
62007.95	2480x200	62507.95	2480x300
62009.95	2980x200	62509.95	2980x300



CLADDING END PANEL H25 PERFORATED

Ref. 26

component	height x depth mm	component	height x depth mm
62701.95	1485x200	62901.95	1485x300
62704.95	1940x200	62904.95	1940x300
62707.95	2480x200	62907.95	2480x300
62709.95	2980x200	62909.95	2980x300



**FASTENING CLIP FOR
BACK CLADDING H12 - Ref. 27**

component

67010.95



**FASTENING CLIP FOR
BACK CLADDING H25 / H29 - Ref. 27**

component

68108.95



**FASTENING CLIP FOR
END CLADDING H25 - Ref. 28**

component

68107.95

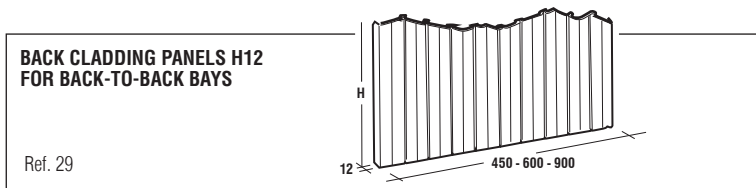

**BACK CLADDING PANELS H12
FOR BACK-TO-BACK BAYS**

Ref. 29

component	height x depth mm	component	height x depth mm	component	height x depth mm
63510.95	1485x450	63001.95	1485x600	63501.95	1485x900
63513.95	1940x450	63004.95	1940x600	63504.95	1940x900
63516.95	2480x450	63007.95	2480x600	63507.95	2480x900
63518.95	2980x450	63009.95	2980x600	63509.95	2980x900

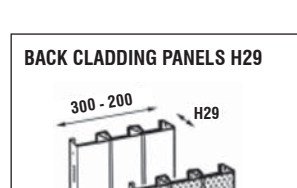

BACK CLADDING PANELS H29

Ref. 27

component	depth mm	version
63101.95	300	smooth
63110.95	300	punch hole
63107.95	300	ribbed
63104.95	300	perforated
63111.95	200	smooth
63120.95	200	punch hole
63117.95	200	ribbed
63114.95	200	perforated

SUPER 1-2-3

ACCESSORIES FOR SUPER 1-2-3 SHELVING SERIES

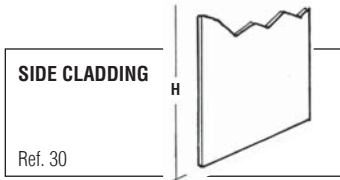

component	height x depth mm
67501.95	1485 x 320
67504.95	1940 x 320
67507.95	2480 x 320
67508.95	2980 x 320
67510.95	1485 x 400
67513.95	1940 x 400
67516.95	2480 x 400
67517.95	2980 x 400
67519.95	1485 x 500
67522.95	1940 x 500
67525.95	2480 x 500
67526.95	2980 x 500
67528.95	1485 x 600
67531.95	1940 x 600
67534.95	2480 x 600
67535.95	2980 x 600

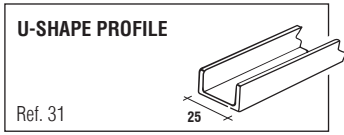

component	length mm
for H25	69800.95 4000
for H29	69801.95 4000
for H58	69807.95 4000
for H68	69808.95 4000

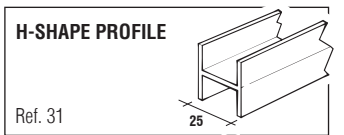

component	length mm
for H25	69803.95 4000
for H29	69804.95 4000
for H58	69810.95 4000

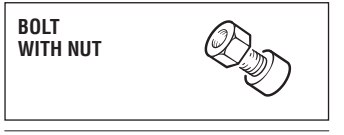

bolt	nut	length mm
00005.20	00020.20	6 x 20



component	nominal height mm	steps
00008879.98	2000	5
00008880.98	2500	7
00008881.98	3000	9



component	length mm
00008894.85	900
00008895.85	1050
00008896.85	1200
00008897.85	1350
00008898.85	1500
00008899.85	1650
00008900.85	1800

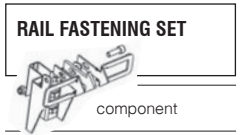

component
00008888.98

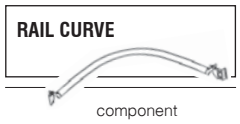

component
00008890.85

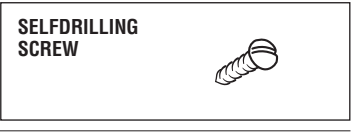

component	length mm
00016.20	6 x 18

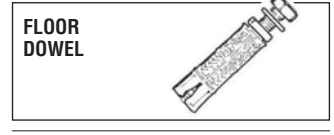

component	length mm
00040.20	8 x 50

CROSS BRACING SUPER 1-2-3 SHELVING

Regarding design, calculation, assembly instructions and ordering, please refer to the technical manual "ISQ03_04/C-012 - CROSS BRACINGS FOR LIGHT DUTY SHELVING"

CROSS BRACING SUPER 1-2-3 SERIES

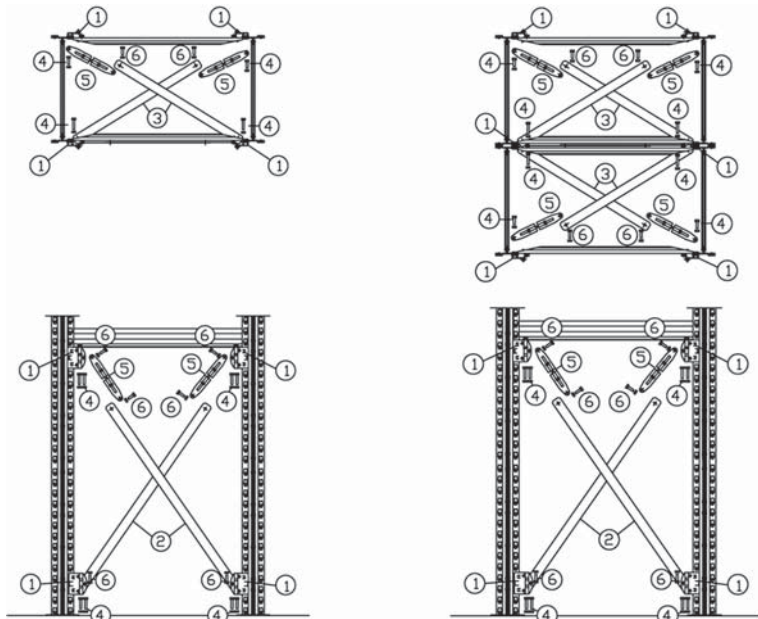

CROSS BRACING SUPER 1-2-3 SERIES

Cross bracings (horizontal and vertical ones) have to be used in Super 1-2-3 shelving structures with frame heights exceeding 3000 mm. The sketches shown above explain the make up and assembly of the cross bracing concept referring to a 3000 mm high frame within a single and double sided shelving row.

MACROCODE 67023.98 for single sided shelving. The macrocode 67023.98 comprises all components shown in the sketch, except items 2-3

MACROCODE 67024.98 for double sided shelving. The macrocode 67024.98 comprises all components shown in the sketch, except items 2-3

item	Macrocode 67023.98 q.ty. of components
68051.95	6
68053.95	8
00020.20	28
00027.20	16
00035.20	8
00036.20	4

item	Macrocode 67024.98 q.ty. of components
68051.95	8
68053.95	12
00020.20	40
00027.20	24
00035.20	10
00036.20	6

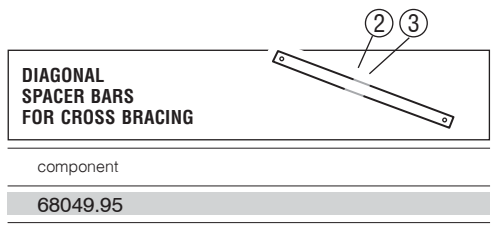

component
68049.95

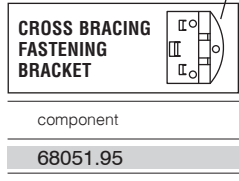

component
68051.95

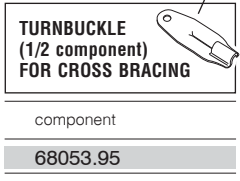

component
68053.95

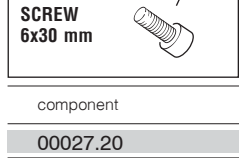

component
00027.20

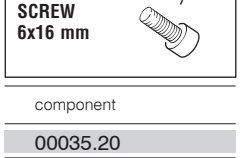

component
00035.20

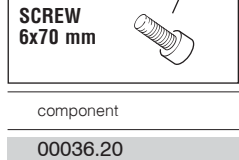

component
00036.20

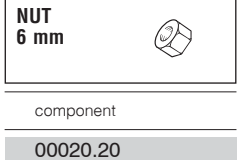

component
00020.20

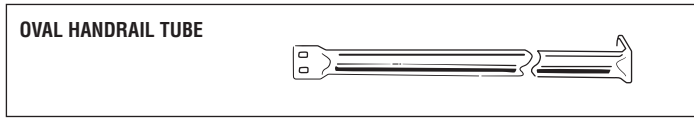

OVAL HANDRAIL TUBE

component

- 67401.95 for walkway end
- 67402.95 for inside end frame

For walkway ends, order article n° 67401.95, specifying the length of the spacer bars used to build the walkway.
In the case of end frames, order art. n° 67402.95, specifying the length of the spacer bar used to build the frame. For handrails between bay uprights order the oval tubular beam in material gauge 10/10 mm, article numbers 36501.95 - 36510.95 (see below).

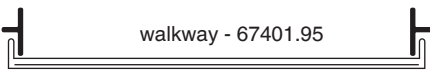

walkway - 67401.95

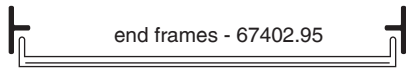

end frames - 67402.95

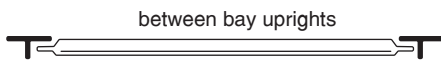

between bay uprights

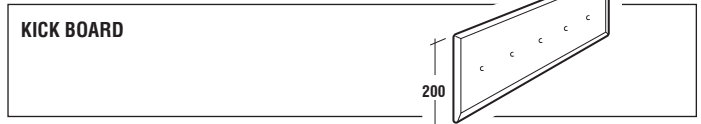

KICK BOARD

component

- 67405.95 for walkway end
- 67404.95 for inside end frame
- 67403.95 between bay uprights

The kick boards are made from two oval tubular beams (the same used to create the handrails) fixed to the uprights and a sheet metal element fastened to the oval tubular beams with self tapping screws (art. n° 00017.20).
For walkway ends, order art. n° 67405.95, specifying the length of the spacer bars used to build the walkway. For end frames, order art. n° 67404.95, specifying the length of the spacer bars used to build the frames. As for longitudinal kick boards, order art. n° 67403.95, specifying the length of the oval tubular beam.

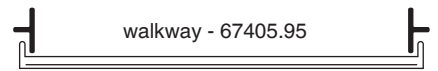

walkway - 67405.95

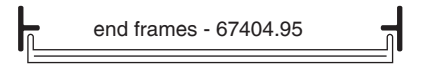

end frames - 67404.95

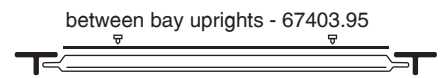

between bay uprights - 67403.95

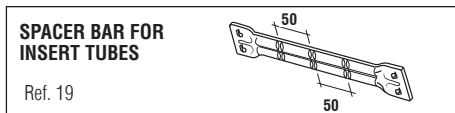

SPACER BAR FOR INSERT TUBES

Ref. 19

component	depth mm	q.ty of notches to locate oval insert tubes
67821.95	320	3
67822.95	400	5
67823.95	500	7
67824.95	600	9
67825.95	700	11
67826.95	800	13

Att.: please, refer to METALSISTEM Informa" n° 296 for design and load bearing capacity.



OVAL INSERT TUBES FOR SPACER BARS

Ref. 19

component	length mm
67421.95	900
67424.95	1200
67427.95	1500
67430.95	1800



ROW SPACER TIE BAR (clear span)

Ref. 49

component	depth mm
67400.95	clear span

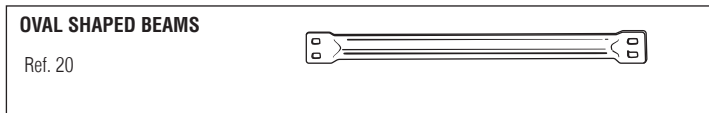

OVAL SHAPED BEAMS

Ref. 20

component	mat. gauge mm	load cap. <daN> u.d.l. per beam	length mm	component	mat. gauge mm	load cap. <daN> u.d.l. per beam
36501.95	10/10	175	900	36801.95	18/10	295
36504.95	10/10	120	1200	36804.95	18/10	200
36507.95	10/10	75	1500	36807.95	18/10	130
36510.95	10/10	52	1800	36810.95	18/10	90

Regarding design and load bearing capacity please refer to "METALSISTEM Informa" n° 292. In the case that the oval shaped beams are used for tyre storage, please refer to "METALSISTEM Informa" n° 353 regarding correct design, application and load bearing capacities.



MODULAR SLIDING GATE

Page 25 of this brochure
METALSISTEM Informa n° 547/613

component	operation with:	serviceable span mm	overall height from walkway level mm
00010780.G1	suspended guide rail	1500	1118
00010781.G1	suspended guide rail	2000	1118
00019650.G1	guide rail on ground	1500	1168
00019651.G1	guide rail on ground	2000	1168



STEEL BASE PLATE

Ref. 1

component

- 67001.95



PLASTIC BASE PLATE AND TOP CAP FOR SINGLE UPRIGHTS

Ref. 1 / Ref. 20

component

- 68055.98



PLASTIC BASE PLATE AND TOP CAP FOR DOUBLE UPRIGHTS

Ref. 1

component

- 67005.98



HEAVY DUTY BASE PLATE

Ref. 1

component

- 67006.95



SHIMS FOR STEEL BASE PLATES

Ref. 1

component	gauge
66999.95	1 mm
67000.95	2 mm



PLASTIC LABEL HOLDER

Ref. 23

component

- 67008.98

SUPER 1-2-3

ACCESSORIES FOR SUPER 1-2-3 SHELVING SERIES

DRAWER

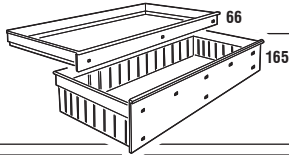

Page 11/18/19

component	length mm	height mm	depth mm
67830.98	900	66	400
67831.98	900	66	500
67832.98	900	66	600

67833.98	1200	66	400
67834.98	1200	66	500
67835.98	1200	66	600

67883.98	1500	66	400
67884.98	1500	66	500
67885.98	1500	66	600

67836.98	900	165	400
67837.98	900	165	500
67838.98	900	165	600

67839.98	1200	165	400
67840.98	1200	165	500
67841.98	1200	165	600

67886.98	1500	165	400
67887.98	1500	165	500
67888.98	1500	165	600

KEY LOCK FOR DRAWER

Each cylinder lock is provided with two keys of the respective coding scheme. See METALSISTEM Informa n° 679



Page 18

article	Key Coding Scheme	article	Key Coding Scheme
---------	-------------------	---------	-------------------

AL210099.801.21	801	AL210099.806.21	806
AL210099.802.21	802	AL210099.807.21	807
AL210099.803.21	803	AL210099.808.21	808
AL210099.804.21	804	AL210099.809.21	809
AL210099.805.21	805	AL210099.810.21	810

CLIPS FOR SLIDING DIVIDERS

Ref. 11

component

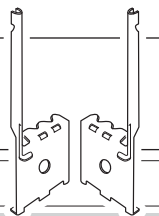

68109.95 (one couple)

SLIDING DIVIDER H100/H200

Ref. 11

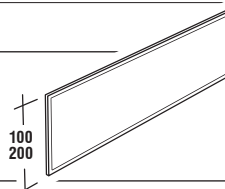

component	depth mm	height mm
67200.95	320	100
67204.95	400	100
67206.95	500	100
67208.95	600	100
67210.95	700	100
67212.95	800	100

67220.95	320	200
67222.95	400	200
67224.95	500	200
67226.95	600	200
67228.95	700	200
67230.95	800	200

PERFORATED DRAWER WALL

Page 18

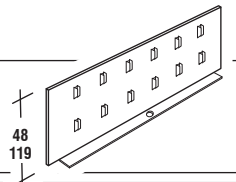

component	height mm	depth mm	for drawer height mm
67842B.95	48	400	66
67843B.95	48	500	66
67844B.95	48	600	66

67842A.95	119	400	165
67843A.95	119	500	165
67844A.95	119	600	165

DIVIDER FOR DRAWER

Page 18

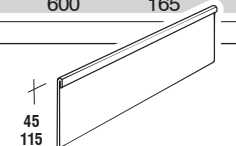

component	height mm	length mm	for drawer height mm
67845B.95	45	50	66
67846B.95	45	100	66
67847B.95	45	150	66

67848B.95	45	200	66
67849B.95	45	300	66
67850B.95	45	400	66

67845A.95	115	50	165
67846A.95	115	100	165
67847A.95	115	150	165

67848A.95	115	200	165
67849A.95	115	300	165
67850A.95	115	400	165

FASTENING CLIP FOR MODULAR CONTAINER

Ref. 66



article

AL210005.95

TRAPEZ. SLIDING DIVIDER

Ref. 11

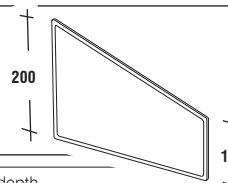

component	depth mm
67170.95	320
67172.95	400
67174.95	500
67176.95	600
67178.95	700
67180.95	800

SHELF BOARD

Ref. 40



component	height x length mm
64016.95	200 x 900
64019.95	200 x 1200
64022.95	200 x 1500
64025.95	200 x 1800

64031.95	300 x 900
64034.95	300 x 1200
64037.95	300 x 1500
64040.95	300 x 1800

MODULAR CONTAINERS

Ref. 9-10

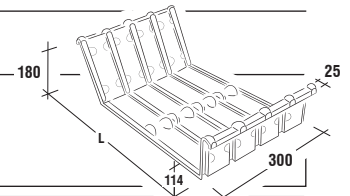

component	depth mm	load capacity <daN> u.d.l.
61017.95	320	90
61018.95	400	90
61019.95	500	70
61020.95	600	65
61021.95	700	60
61022.95	800	60

DIVIDERS FOR MODULAR CONTAINERS

Ref. 9-10

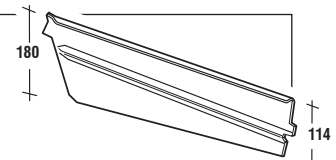

component	depth mm
61517.95	320
61518.95	400
61519.95	500
61520.95	600
61521.95	700
61522.95	800

BIN FRONT OR REAR FOR SHELF TRAYS

Ref. 13

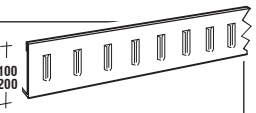

component	height x length mm
64101.95	100 x 900
64104.95	100 x 1000
64107.95	100 x 1200
64110.95	100 x 1500
64113.95	200 x 900
64116.95	200 x 1000
64119.95	200 x 1200
64122.95	200 x 1500

DIVIDER H100/H200 FOR SHELF TRAYS

Ref. 13

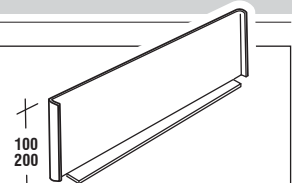

component	depth mm	height mm	component	depth mm	height mm
67151.95	320	100	67152.95	320	200
67154.95	400	100	67153.95	400	200
67157.95	500	100	67155.95	500	200
67160.95	600	100	67156.95	600	200
67162.95	700	100	67158.95	700	200
67164.95	800	100	67159.95	800	200

TRAPEZOIDAL DIVIDERS H 200/100 FOR SHELF TRAYS

Ref. 14

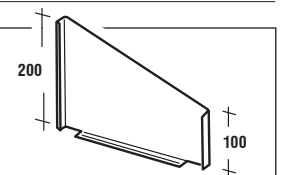

component	depth mm	component	depth mm
67181.95	320	67190.95	600
67184.95	400	67192.95	700
67187.95	500	67194.95	800

FIXED HEIGHT DIVIDERS
Ref. 16

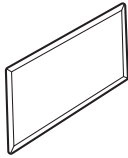

component	depth mm	height mm
67720.95	320	244
67722.95	400	244
67724.95	500	244
67726.95	600	244
67728.95	700	244
67730.95	800	244
67740.95	320	344
67742.95	400	344
67744.95	500	344
67746.95	600	344
67748.95	700	344
67750.95	800	344
67760.95	320	444
67762.95	400	444
67764.95	500	444
67766.95	600	444
67768.95	700	444
67770.95	800	444

CLIPS FOR FIXED HEIGHT DIVIDERS
Ref. 16



component	description
68110.95	double-sided
68111.95	single-sided

CHIPBOARD CLIP
Ref. 8



component	description
67025.95	

REINFORCING BRACKET FOR UPRIGHTS
Ref. 50



component	description
65023.95	

HANDRAIL FASTENING KIT FOR STAIRCASES
Ref. 45



Art.	made from following components:	q.ty
00007406.98	PLASTIC WHEEL	2
00007414.98	SQUARE INSERT WITH HOLE ø 8MM	1
00013513.20	M8X80 CSSH BOLT UNI5933 ZB	1
00014509.20	M6X20 CHS BOLT 8,8 DIN912 ZP	2
00020.20	M6 NUT 8 DIN934 ZP	2
00021.20	M8 NUT 8 DIN934 ZP	1
65005/A.95	RIGHT CONNec. HANDRAIL S123/US	1
65005/B.95	LEFT CONNec. HANDRAIL S123/US	1
SI03A018.85	CLIP WITHOUT THR.+LUGS THR.SID	1
SLACC089.95	UNIRACK BRACING BRACKET	1

T-SECTION SUPPORT BRACKET
Ref. 36



FRAME BACK-TO-BACK CLAMPS
Ref. 24

component	description	q.ty
67022.95		

WALKWAY BEAM
METALSISTEM Informa n° 665
Ref. 57

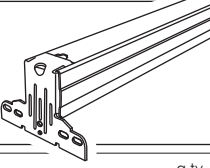

component	description	q.ty
AI210013.95	Walkway Beam Profile 70X70/6	1
AI210082.95	Walkway Beam Connector	2
00058.20	Screw 5.5X19	2

WALKWAY SUPPORT T-SECTION BEAM - H58 (inner frame)
Ref. 36-37

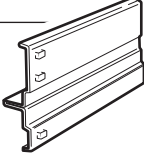

component	length mm	load capacity <daN> per pair - u.d.l.
67320.95	900	1000
67322.95	1200	750
67324.95	1500	600

WALKWAY SUPPORT T-SECTION H58 FOR WALKWAYS LENGTH = 6200 MM
Ref. 35



component	description
67015.95	

TOP CAP FOR T-SECTION SUPPORT BAR H58
Ref. 38



component	description
67026.98	

HANDRAIL made from profile section
Ø 32x32mm
Ref. 45

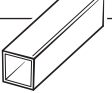

component	description	length mm
SI01C500.85	INOX 32/22 BEAM PROFILE	5000
ZN04C600.95	GALVAN. BEAM PROFILE 32/4	6000

NYLON PLUG FOR HANDRAIL
Ref. 45



component	description
SI01A003.98	

PLASTIC STRIP FOR TYRES
LENGTH = 3000 MM
Ref. 21

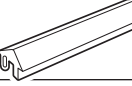

component	description
67020.98	

NOISE DAMPENING ADHESIVE STRIP
LENGTH = 10 METERS
Ref. 35



component	description
67021.98	

REINFORCED UPRIGHT SUPER-3
with a Unirack upright profile riveted back-to-back onto the Super-3 upright
See page 32/33 - Ref. 44
as well as METALSISTEM Informa n° 653



component	reinforced up to height <mm>	component	reinforced up to height <mm>
9923018.95	1800	9923023.95	2300
9923019.95	1900	9923024.95	2400
9923020.95	2000	9923025.95	2500
9923021.95	2100	9923026.95	2600
9923022.95	2200	9923027.96	2700

WALL FASTENING BRACKET
Ref. 34

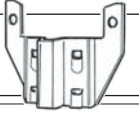

component	description
65022.95	

PVC HANDRAIL JOINT - 65 MM
Ref. 48

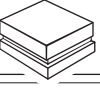

component	description
69840.98	

PVC JOINT FOR HANDRAIL INTERSECTION AT RIGHT
Ref. 48

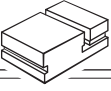

component	description
69837.98	

PVC JOINT FOR HANDRAIL INTERSECTION AT LEFT
Ref. 48

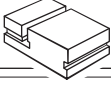

component	description
69843.98	

STEEL PLANK FIXING BRACKET
Ref. 54 pag. 39

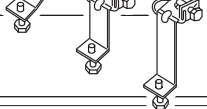

component	description
69829.95	
00056.20	

Steel Plank Clamp	M8x16 Bolt	up to profile height	
Bracket + Bolt	10x20 mm	20mm	69861.98
Bracket + Bolt	10x20 mm	40mm	69862.98
Bracket + Bolt	10x20 mm	60mm	69863.98
Steel Plank Fixing Bracket + Bolt	8x40 mm	40mm	69864.98

(includes already the components 69829.95 and 00056.20)

LOCKABLE DOOR,
Standard Finish: Grey RAL 7001



component	length x height mm
68201.98	900x2000H
68204.98	1200x2000H
68207.98	1500x2000H
68210.98	900x2500H
68213.98	1200x2500H
68216.98	1500x2500H

LOCKABLE SLIDING DOOR

- available in zinc coated version or powder coated.
- standard colour blue, RAL 5010 - other colours available upon request
- see also METALSISTEM Informa n° 583

Ref. 63



bay length x height mm	zinc coated version component	powder coated version component
900x2000H	68220.95	68220.--
1200x2000H	68222.95	68222.--
1500x2000H	68224.95	68224.--
900x2500H	68230.95	68230.--
1200x2500H	68232.95	68232.--
1500x2500H	68234.95	68234.--



Ref. 63



Ref. 62

LxDxH overall dimension <mm> 1025/1325/1625x595x1975

STEEL CABINET WITH 4 MODULAR SHELF PANELS made from Super 1 beams and H12 mm panels and lockable sliding doors.
Cabinet available in zinc coated version or with powder coated cladding. Standard colours: red RAL 3000, blue RAL 5010, yellow RAL 1004.

Ref. 62

CLADDING SET made from side/back/top (*) cladding panels.

(*) top cladding panel standard zinc coated
Cladding Set includes fastening accessories Ref. 62

bay length x depth x height nominal dimension mm	zinc coated version component	powder coated version component	zinc coated version component	powder coated version component
900x500x2000	MS210001.95	MS210001.--	MS210004.95	MS210004.--
1200x500x2000	MS210002.95	MS210002.--	MS210005.95	MS210005.--
1500x500x2000	MS210003.95	MS210003.--	MS210006.95	MS210006.--

CORNER BRACKETS

Ref. 67 – Page 14



Macrocode	description
AL 210116.95	Kit of Corner Brackets - Right made from:
AL 210108.95	Corner Bracket Upright - Right
AL 210112.95	Corner Bracket Beam - Right
AL 210117.95	Kit of Corner Brackets - Left made from:
AL 210109.95	Corner Bracket Upright - Left
AL 210113.95	Corner Bracket Beam - Left

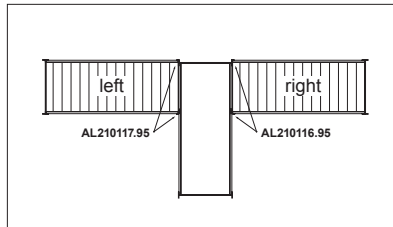

AL 210120.95 Kit of Brackets for "T" Configuration made from:

AL 210112.95	Corner Bracket Beam - Right
AL 210113.95	Corner Bracket Beam - Left

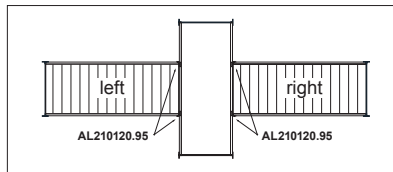

REINFORCEMENT BAR

Ref. 65 Page 34/35

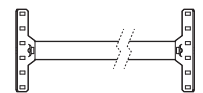

article	length mm
AL210101.95	900
AL210102.95	1050
AL210103.95	1200
AL210104.95	1350
AL210105.95	1500
AL210106.95	1650
AL210107.95	1800

Reinforcement bars may be ordered in either of the following modalities:

- preassembled items for standard nominal bay dimensions from 900 to 1800 mm in length; see above code numbers.
- loose items that may be assembled on site following the assembly instructions "ISTM-298";

Please also refer to METALSISTEM Informa n 706.

article	description	q.ty
AL210100.95	Connection Bracket	2
VI000175.20	Screw Peg M8x30 mm	2
36002.95	Oval Tubular Profile, zinc coated	1

Notes:

- The oval tubular profile has been ordered in real dimensions, i.e.: real dimension = nominal dimension - 89 mm.
- Screw pegs are supplied in standard packaging quantities.

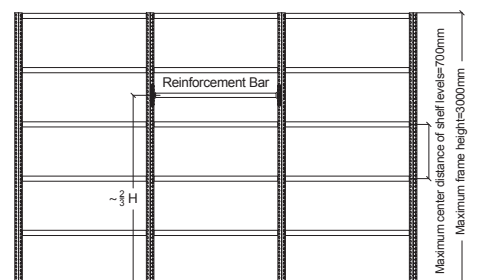

Technical Specifications regarding calculation, layout, maximum load bearing capacity

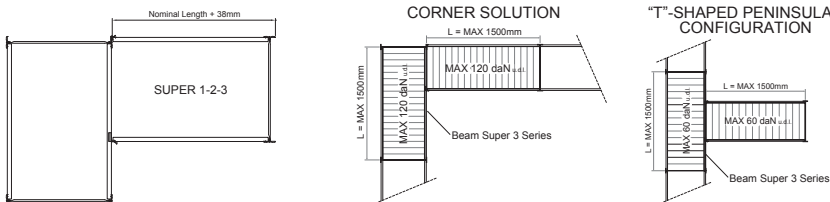

When creating corner solutions of "T"-shaped configurations, please pay attention to the following specifications:

- The corner configuration offers a maximum load bearing capacity of 120daN for both corner and receiving shelves;
- "T" shaped configurations are limited to 60daN per shelf (see sketch above);
- Only Super 3 beams can be used as receiving beams;
- The receiving and corner beam may not be longer than 1500mm;
- No more than two brackets can be placed on a receiving beam ("T" configuration);
- The peninsula of the "T" configuration may be no longer than one sole bay.
- The use of safety clips is mandatory, these are not included in the macrocodes above.

For the correct assembly of corner brackets and use of safety clips for this new solution, please refer to the assembly instruction <Doc. ID ISTM-299> as well as to the indications of METALSISTEM Informa n° 708.

SUPER 1-2-3

PATENTED BOLTFREE SHELVING SYSTEM

DIVIDER FOR EXHAUST PIPES

Ref. 18

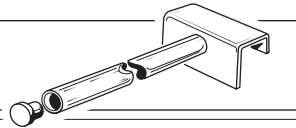

component

67301.98	horizontal
67302.98	vertical

TELESCOPIC TUBE DIVIDERS inner and outer

Ref. 17

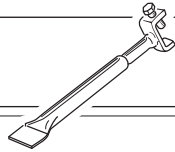

component height mm

67290.95	280 inner
67293.95	280 outer
67296.95	560 inner
67299.95	560 outer



ITEM: Single Sided Plastic Bin Trolley Double Sided Plastic Bin Trolley

component	00005598.98	00005179.98
dimension <LxDxH> mm	720 x 390 x 1210	1120 x 500 x 1240
load levels	6 single sided levels	7 double sided levels

Description: trolley on four rubber rimmed swivelling castors, two with brakes.

Designed to accommodate BULL plastic bin series on 6 or 7 levels in height, respectively.

Suited for BULL-1 to BULL-3 plastic bin series.

The trolleys are supplied preassembled in kit form; the kit does not contain the modular plastic bins, these need to be ordered separately.

SUPER 1-2-3 LIGHT DUTY DYNAMIC STORAGE SOLUTIONS - CARTON FLOW

FLOW TRACK PROFILES

Page 37

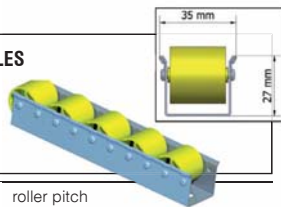

component roller pitch mm

00004816.95	33
00004817.95	49,5
00004818.95	66
00004819.95	82,5
00004820.95	99

SCREENSTRIP FOR FLOW TRACK PROFILES

Page 37



component bay length mm

00019796.95	900
00019797.95	1200
00019798.95	1500

article code

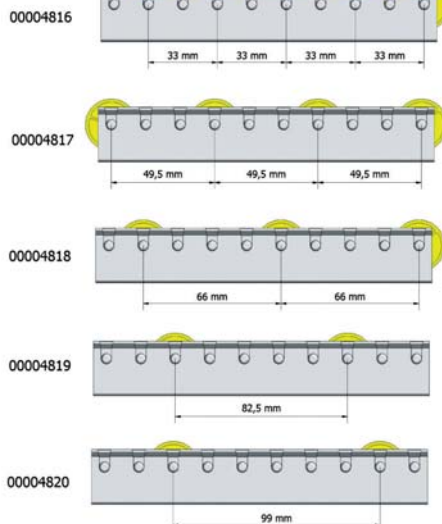

REMOVABLE ROLLER BED DIVIDER

Page 37

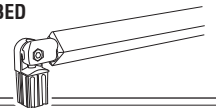

article description

ZN04M000.95	galvanised profile 32/4 spec.
MH210001.98	roller bed separator joints

RUNWAY DIVIDER FOR ROLLER SHELVES

Page 37



component runway depth mm

00007963.95	624
00006421.95	1285
00004357.95	support profile for runway divider

LOAD BEARING CAPACITY <daN> OF SINGLE FLOW TRACK PROFILES

distance between supports mm	00004816 33 mm	00004817 49,5 mm	00004818 66 mm	00004819 82,5 mm	00004820 99 mm
200	18	12	9	7	6
300	27	18	14	11	9
400	36	24	18	15	12
500	36	30	23	18	15
600	31	31	27	22	18
700	27	27	27	25	21
800	20	20	20	20	20
900	16	16	16	16	16
1000	13	13	13	13	13
1100	11	11	11	11	11
1200	9	9	9	9	9
1300	8	8	8	8	8
1400	7	7	7	7	7
1500	6	6	6	6	6
1600	5	5	5	5	5
1700	5	5	5	5	5
1800	4	4	4	4	4
1900	4	4	4	4	4
2000	3	3	3	3	3

FLOW TRACK CUT PITCHES mm

359	821	1283	1745	2207	2669	3131	3593
392	854	1316	1778	2240	2702	3164	3626
425	887	1349	1811	2273	2735	3197	3659
458	920	1382	1844	2306	2768	3230	3692
491	953	1415	1877	2339	2801	3263	3725
524	986	1448	1910	2372	2834	3296	3758
557	1019	1481	1943	2405	2867	3329	3791
590	1052	1514	1976	2438	2900	3362	3824
623	1085	1547	2009	2471	2933	3395	3857
656	1118	1580	2042	2504	2966	3428	3890
689	1151	1613	2075	2537	2999	3461	3923
722	1184	1646	2108	2570	3032	3494	3956
755	1217	1679	2141	2603	3065	3527	3989
788	1250	1712	2174	2636	3098	3560	4022

Notes: the flow track profiles are made from galvanised, high tensile steel. The yellow polypropylene plastic rollers are inserted into the tracks at varying pitches of either 33, 49.5, 66, 82.5 or 99 mm. The load bearing capacity of the flow track profile has been calculated on the basis of the application of a uniformly distributed load respecting both tensile strength and a deflection of <L/500. ("L" is the distance between supports, ranging from 200 to 2000 mm). The maximum load bearing capacity of a single roller is 3 daN.

SIMPLY SUPER – DO-IT-YOURSELF – PATENTED BOLTLESS SHELVING KITS

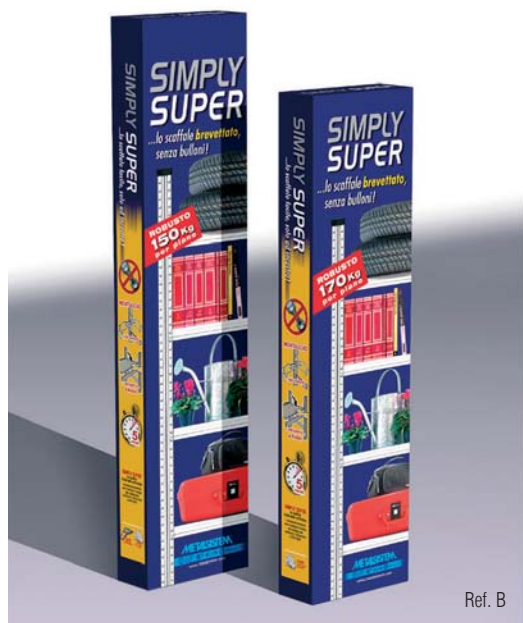

Ref. B



Ref. A



Ref. A



“SIMPLY SUPER” are DO-IT-YOURSELF shelving kits, conceived for easy use within the domestic environment. Simply Super is available in two different heights - 1840 and 1576 mm - with 5 or 4 shelf levels in height, respectively. Two shelf options are available: plastic panels or steel shelf panels. Starter bays can be easily integrated with add-on-bays. All of them in 900 mm width and 400 mm depth. Shelves can be regulated in height at a 33 mm pitch. Simply Super is made from prime quality high tensile steel, certified according to EN 10204 3.1.

component	shelving kit to build a:	nominal bay dimensions L x D x H - mm	shelf panel type & q. ty
75000.98	starter unit	1000 x 400 x 1576	4 steel shelves
75000C.98	add-on-unit		
75001.98	starter unit	1000 x 400 x 1840	5 steel shelves
75001C.98	add-on-unit		
75002.98	starter unit	1000 x 400 x 1576	4 plastic shelves, yellow
75002C.98	add-on-unit		
75003.98	starter unit	1000 x 400 x 1576	4 plastic shelves, light blue
75003C.98	add-on-unit		

component	description	box height mm
75105/E.98	Packaging set	1580
see Ref. A above:	composed of cardboard box + sticker + flyer	
75107/E.98	Packaging set	1850
see Ref. A above:	composed of cardboard box + sticker + flyer	
75100I.98	Screen Print Box	1580
see Ref. B above		
75101I.98	Screen Print Box	1850
see Ref. B above		

PLASTIC LINE (Page 19)

See more on the web



Open fronted bins with very strong structure. Easily to be placed one upon another. Large front label holder. Made from high density polyethylene. Fracture and breakage proof. Resistant to acids, oils, solvents and detergents. Ergonomic line with comfortable handles for lifting. Base completely flat and anti-skid. Full length return to clip to louvred panels. Brilliant colours and pleasant design.



BULL 1 / K1

L. 105 x D. 88/70 x H. 54 mm

Package of 100 pcs.



BULL 2 / K2

L. 105 x D. 167/140 x H. 82 mm

Package of 48 pcs.



BULL 3 / K3

L. 144 x D. 237/190 x H. 123 mm

Package of 38 pcs.



BULL 4 / K4

L. 205 x D. 345/270 x H. 164 mm

Package of 24 pcs.

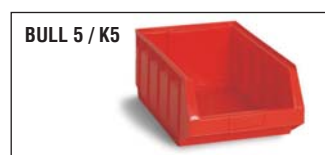

BULL 5 / K5

L. 298 x D. 485/400 x H. 189 mm

Package of 12 pcs.



BULL 6/D



BULL 6
K6/D
K6

● = available without fixed divider

L. 372 x D. 600/460 x H. 250 mm

Package of 4 pcs.



BULL 7



BULL 7/D

◆ = available with fixed divider

L. 442 x D. 700/540 x H. 300 mm

Package of 4 pcs.

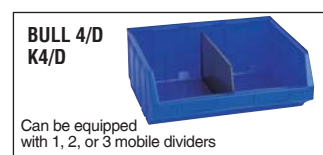

BULL 4/D



Can be equipped
with 1, 2, or 3 mobile dividers

L. 406 x D. 345/270 x H. 164 mm

Package of 8 pcs.

METALSISTEM



Our dedication to making a difference: creating **MORE VALUE** with **LESS IMPACT!**
 METALSISTEM is proud to adopt **ECO-EFFICIENCY** concepts in its business model.
 ZERO emission and ZERO ecological impact thanks to a **UNIQUE MANUFACTURING PROCESS!**
 METALSISTEM has achieved energy self-sufficiency through the use of renewable resources.



See more on the web

SUPER 1 / 2 / 3



MODULAR STEEL STORAGE SYSTEMS